

New!
Preliminary

Programmable Intelligent Controllers WITH "QUAD" LCD (Switchboard) DISPLAY

**MODEL
HI-Q127**

FEATURES:

- * 51 Segments (2%) Display
- * 1 ea. 3 Character 7 Segment 0.4" High
- * 1 ea. 3 Digit Display 0.6 " (888)
- * 1 ea. 7 Digit Display 0.4" High (888,8888) (Analog Reading, 6 digits)
- * Auto-Tricolor Backlight (R/G/A)
- * Isolated 18-Bit A/D(50K Counts)
- * Look Up Tables, Math Functions
- * RS232, 485,422 OR USB I/O
- * 3 Channel Analog Inputs with > 30 signal conditioners
- * 4 Relays SPDT 10A
- * 8 Open Coll. XTRS (O.C.T.)
- * Isolated 16 Bit DAC (4-20mA) Out
- * Isol. 28 VDC Out for Transmitter
- * Lifetime (LTD) Warranty!

SPECIFICATIONS:
See Pages A-D Attached

Description:

O TEK's new HI-Q127 joins the popular "Switchboard" series of Intelligent Programmable Controllers which are used in aerospace, nuclear, military & industrial fields. The HI-Q127 shares the same hardware (other than the glass) & software already tested to Mil-Std 461E, 617 and SV&V (Software Verification & Validation), so it is proven to have a long life expectancy and high reliability.

Its 3 Input A/D Channels (18-Bit Resolution) allows the end user to display & control (via analog output or relays) any 3 variables as in flow (actual & accumulated) applications. The HI-Q127's visual HMI's (Human to Machine Interface) Auto-Tricolor Backlight allows the operator to see color changes (red, amber, green) for quick and long distance viewing, giving the operator a visual of their process (just like traffic lights!). The backlight's color is controlled by programmable alarm set points or with a serial command.

If you would prefer a "power meter", Use the HI-Q127 for V, A, Hz or Watts RMS & Display all variables in one compact instrument.

SWITCHBOARD



SANITARY CASE



EXPLOSION PROOF



NEW TRICOLOR BACKLIGHT:
AUTOMATIC TRICOLOR (R/G/A) BACKLIGHT ALLOWS YOU TO CHANGE BACKGROUND COLORS AT WILL VIA SERIAL COMMANDS OR SET POINTS, INCLUDING BLINKING.

- APPLICATIONS:**
- * Serial Input Remote Display
 - * DCS/SCADA Terminal
 - * Stand Alone Display/Controller
 - * Flow, Volume and Speed Indicator
 - * AC Power Meter (A, V, W & Hz)



**If You Don't
See It
Ask For It!**

- NEW SANITARY CASE!**
- Only 6 X 6 X 3" Aluminum
 - Double Gasketed and 3/4" NPT
 - High Temperature/Impact Window
 - Wall/Panel/Pipe Mounting
 - Up to 250°F Steam Cleaning
 - Water Tight/Submersible

- WHAT IS IT**
- ◆ It is a Programmable Logic Controller (P.L.C.)
 - ◆ It is a Computing Controller
 - ◆ It is a DCS to Process Interface
 - ◆ It is a Process to SCADA Interface
 - ◆ It is a Single Loop Process Controller
 - ◆ Or Just a *Plain METER*

- EXPLOSION PROOF:**
- Approved for:
Class I Div 1 & 2 Groups B, C & D;
Class II Div 1 & 2 Groups E, F & G;
Class III Nema 3,4,7 & 9, FM, CSA, Baseefa & Cenelec Certified
 - Tempered Glass Window
 - Aluminum Casted Housing

520-748-7900
FAX: 520-790-2808
E-MAIL:sales@otekcorp.com
http://www.otekcorp.com



4016 E. TENNESSEE ST.
TUCSON, AZ. 85714 U.S.A.



HI-Q127 ORDERING INFORMATION 4-17-13

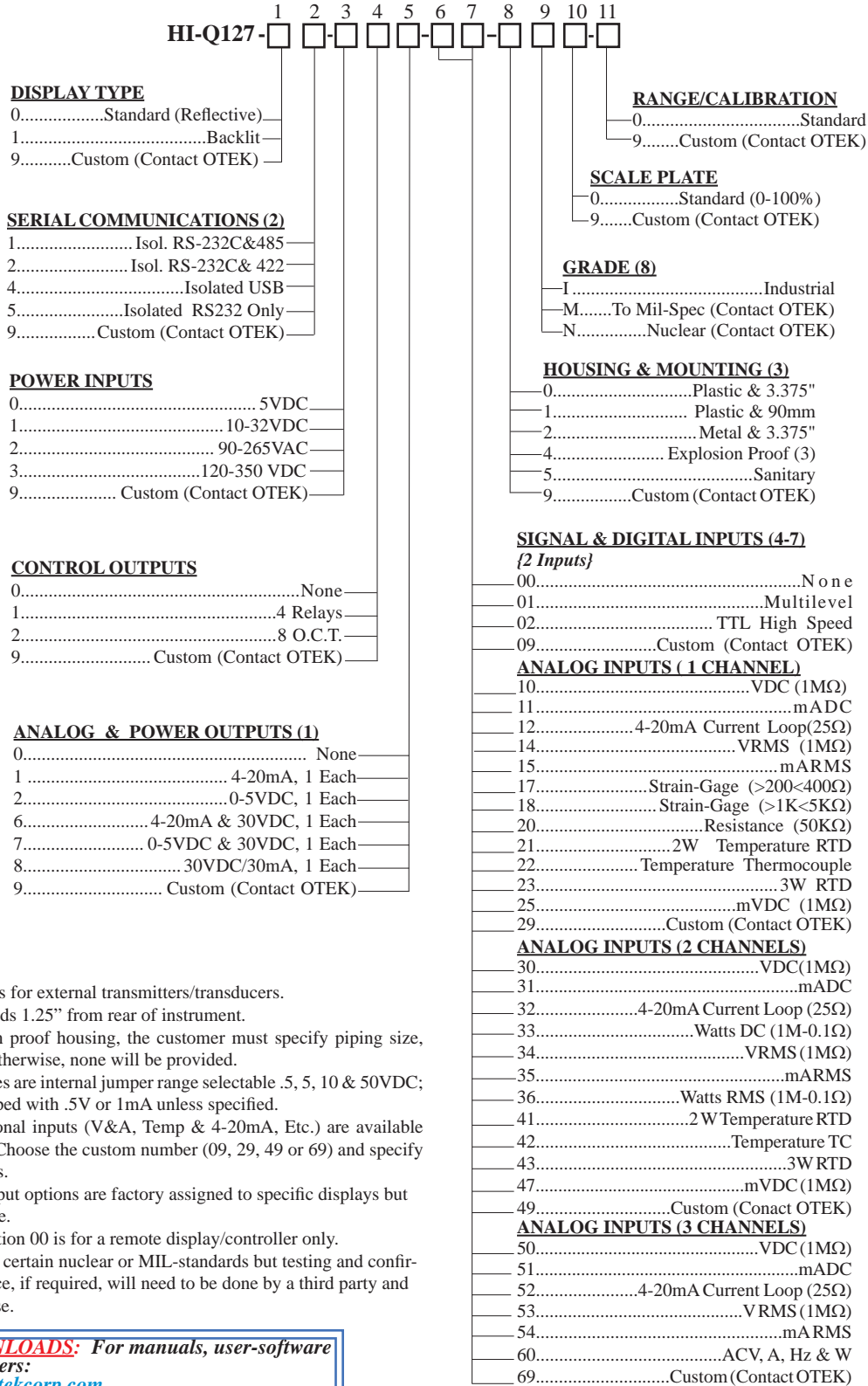

NOTES:

- 30V compliance is for external transmitters/transducers.
- USB option extends 1.25" from rear of instrument.
- For the explosion proof housing, the customer must specify piping size, thread & location; otherwise, none will be provided.
- Volt & Amp ranges are internal jumper range selectable .5, 5, 10 & 50VDC; 1, 5 & 20mA. Shipped with .5V or 1mA unless specified.
- Mixed or additional inputs (V&A, Temp & 4-20mA, Etc.) are available as customizations. Choose the custom number (09, 29, 49 or 69) and specify custom requirements.
- Multi-channel input options are factory assigned to specific displays but are field configurable.
- Digits 6 & 7, Option 00 is for a remote display/controller only.
- Otek will build to certain nuclear or MIL-standards but testing and confirmation of compliance, if required, will need to be done by a third party and at customer's expense.

DOWNLOADS: For manuals, user-software or drivers:
www.otekcorp.com

HI-Q127 MECHANICAL INFORMATION

MECHANICAL FOR ALL OTEK'S "SWITCHBOARD" STYLE METERS

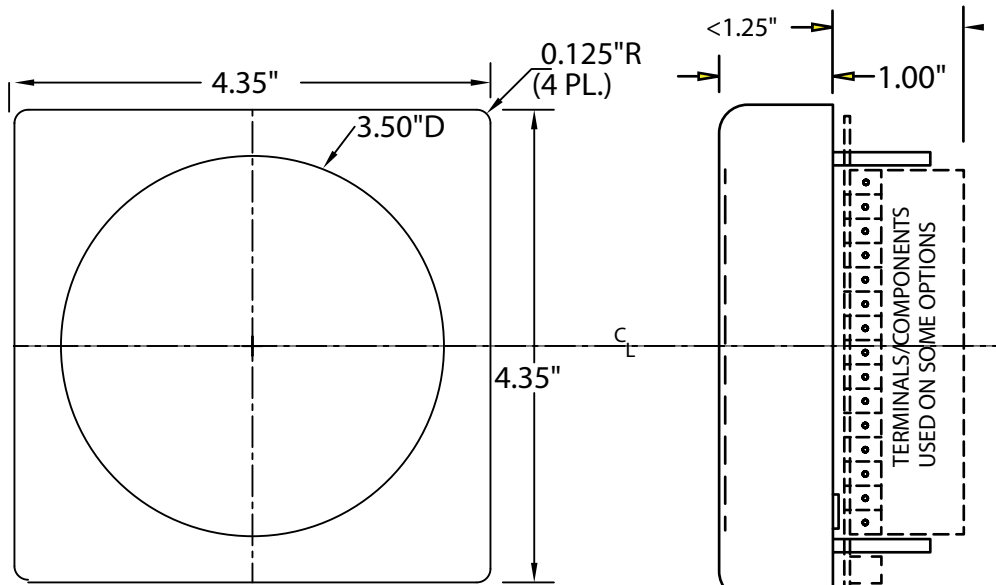

FRONT VIEW

SIDE VIEW

WITHOUT REAR MODULE
SEE NOTE 1

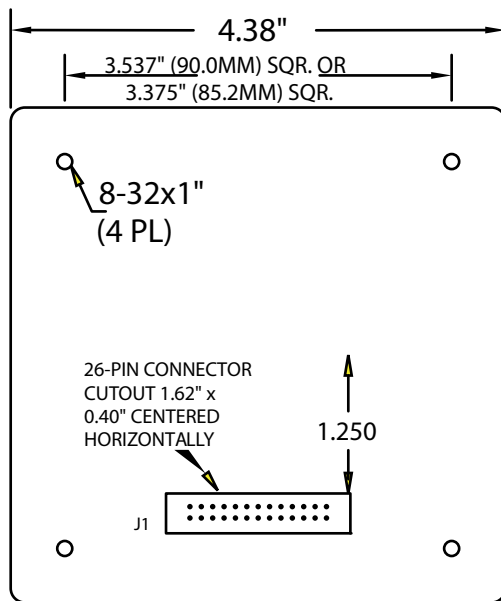

REAR VIEW

WITHOUT REAR MODULE
SEE NOTE 2

Note:

1. Models HI-Q12X-X00-000-0X (X=any option) do not require piggy back module that plugs on J₁ connector from behind your panel, all others do.
2. J₁ connector and 3.375" studs spacing meet ANSI 39.1 standard for switch board meters. J₁ falls within existing "Barrel" cutout and on 1/4 DIN (92x92mm) Panel Cutout.

BENEFITS

OF THE

HI-Q™ (High I.Q.)

DESCRIPTION: The HI-Q Controllers consist of several products with sub-products. All the products share similar hardware and software with the main difference being their package and display. Once you have familiarized yourself with one, you will know them all! By using common software and hardware, we realize R&D and production savings and we are happy to pass them on to you.

INTERFACE

OPERATOR:

- * **Bargraphs** are used for quick trend indication. The operator can, at a glance, tell where the process is.
- * **Digital Display(s)** are used to give accurate process indication and set point control or calculate values in engineering units. They are also used to display the menu-driven prompts.

PROCESS:

- All HI-Q intelligent controllers offer five methods of controlling your process:
- Current: 4-20mA, 1-5mA, 0-20mA (including PID), directly or inversely proportional.
 - Voltage: 0-5VDC & 1-5VDC (or 5-0 & 5-1VDC) or any other ranges in between.
 - Four (4) or six (6) SPDT 10Amp relays.
 - Open collector Bi MOS outputs.
 - The serial port (USB, RS232, 422 & 485)
- Applications: See Technical Brief on Page 27*

BENEFITS

- * **SY & V:** The HI-Q Series software has been verified & validated as trouble/glitch free per IEEE Std. The hardware has passed several Mil-Std's, such as 461, 462, 617, EPRI 102323 & others. If we don't have it, we'll make it!
- * **Low Cost-High Performance:** When you buy the HI-Q, you buy a "Computing Controller," not just an instrument. Its performance-to-price ratio is unsurpassed in the industry. Only the specific functions that you will need are selected and included; no need for unnecessary extras.

SYSTEM:

- * **Use the Isolated RS Translator** to interface with other industry standard USB, RS-232C/RS-422 or RS-485 devices with open or proprietary protocols. If they are "RS" and "ASCII" compatible, the HI-Q can communicate with them.
- * **Stand Alone: as Single or Multi Loop Controller** Whether under the protection of a factory environment or in the open field, the HI-Q will meet and exceed your expectations.

CONFIGURATION: Just Upload OTEK's **FREE Windows Navigator™ (GUI)** and configure or re-configure your HI-Q without an instruction manual in minutes!



COMMON FEATURES

- * **Ready to Use:** Just apply power, select the commands, set your limits and start controlling.
- * **Automatic Tricolor:** Changes colors (Red, Blue, Purple, Green, Amber) upon reaching a limit. **Flashing & dimming** of the displays are under your control.
- * **Password Security:** You can enable or disable the front panel keypad (Optional Keypad).
- * **Emergency Shut Down:** Any three keys held down simultaneously will shut down the controller sending all outputs to a "Fail Safe" (Off) state.
- * **Power on Test (POT):** Will test every major section of its hardware, software and firmware and flag any malfunctions.
- * **C.O.P. (Computer Operating Properly):** Checks the operation of its internal algorithms. You can disable it.
- * **Mathematical Functions:** Insert the math function. Transmit and/or control with the result.
- * **Polynomials and Look Up Tables:** Make your own or use the preprogrammed polynomials to 9th order.
- * **Self-Diagnostics:** The HI-Q will detect major software/hardware failure & warn you via its display/serial port.
- * **Modular Design For Long Life Expectancy**
- * **Lifetime Warranted**
- * **Obsolescence Proof:** All critical components have 2nd source and/or are in modules, so they can be replaced/redesigned efficiently and economically.
- * **Customs:** Very economical and efficient, thanks to its modular design.

Some Commands You Can Enter Via the Optional Keypad (More Via the Serial Port) or GUI

- Security-Code-Restricted Access
- Zero Offset/Tare
- Full-Scale Range
- Colors (LED or LCD backlight) (Any available mix)
- Intensity: None to Max.
- Blinking On/Off
- Filtering (averaging)
- Danger Alarms(Warning/Stop)
- Relays (4 or 6), Bi Mos (8) On-Off
- Current Loops 4-20mA(0-5V out)

1 → 3	Assign any Channel to any
4 → 2	Display & Relays to Channels or External Commands
A/M	* Auto/Manual Process Control
K	Assign any Constant to any Channel
Δt	Assign any Delay to any Output
P	Proportional
I	Integral
D	Derivative
	Your Own Custom Commands
oops!	Reset to Default Parameters
Poly	Ours or Your Polynomials/Tables
...!!	* Process Predictability (Signal(s) vs Time (Contact Otek)

- +, -, x, ÷, √, Σ Selectable
- Alarm w/or w/out Delay
- Watchdog Timer
- COP& Self-Diagnostics
- Store any Non-Volatile Command in Memory
- Any Address Alphanu-meric
- Any speed 1.2 to 19.2 KBPs
- Any Resolution (down to 1÷50,000)

THE BENEFITS OF THE "HI-Q" (Continued)

Now you can monitor and control your process from the comfort of your control room or at the site with an inexpensive PC & OTEK's complete line of **Programmable Intelligent Controllers**. Use them either as a standalone unit or as part of your DCS or SCADA system.

CONFIGURATION with OTEK's New **Windows Navigator™** (PC G.U.I.) is so fast & easy that no instruction manual (other than for connections) is required! Just Plug in your PC terminal, upload our **FREE** program and start selecting your configuration. Within minutes, you will be done, and you can even email it to remote locations!

For a **FREE** copy of the Windows Navigator™, visit our website at www.otekcorp.com and click on Windows Navigator™.

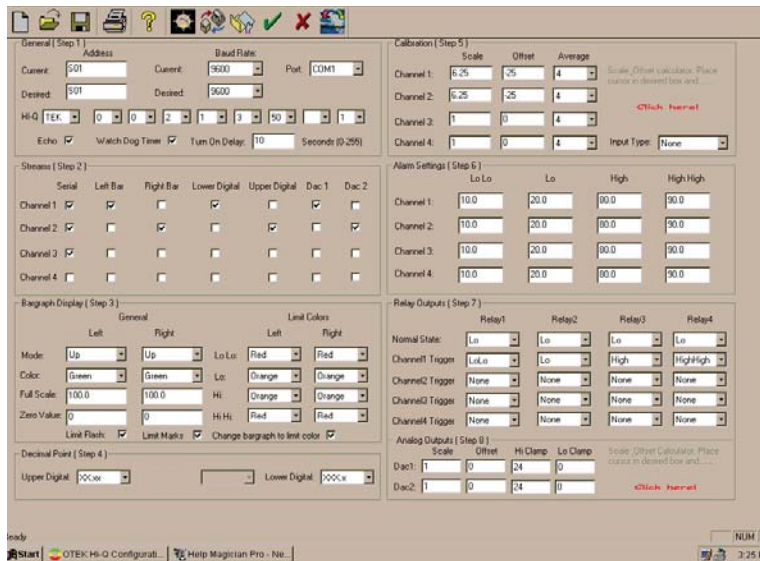

OTEK's "HI-Q" line of **Programmable Intelligent Controllers** with their built-in and isolated signal conditioners will connect directly to your sensor and/or transducer and even power it. All you have to do is to connect & power up. We will even preprogram the "HI-Q" for you if so desired for **"Plug-N-Play"**.

Common Features of the "HI-Q™" Series:

- Math Functions: +, -, x, ÷, √ and More
- Isolated 18-bit A/D w/Signal Conditioners
- Isolated Analog Outputs (4-20mA & 0-5VDC)
- (4 or 6 each) 10A SPDT Relays for On-Off Control
- O.C.T. (250mADC) for Fast On-Off Control
- Isolated 5 & 10-32VDC (24VAC Also) Power Input
- Isolated 90-265VAC or (100-350VDC on Request) Power Input
- 5 VDC Power for Low Voltage Applications
- Look Up Tables for Thermocouples/RTDs
- Polynomials to the 9th Order
- Customer's X-Y (25 Point) Tables
- ZERO • TARE • SPAN • AVERAGE
- All ASCII Characters for Open Protocol
- Programmable Baud Rate & Address
- Isolated RS-232C/422/485 Translator & USB (Ethernet on Request)
- Automatic Tricolor LED Displays with Dimming, Blinking & Pointers
- P.I.D. or Just Plain Proportional Control
- SV & V, Mil-Stds with Self-Diagnostic Capabilities
- Modular Design for Long Life Expectancy
- Lifetime Warranted

What Can the "HI-Q" Series Do for You?

It can accurately and reliably monitor and/or control your process as a standalone unit or as part of a DCS/SCADA for complete factory automation.

From the most basic form as a serial input **remote display** to the most complex as stand alone **Programmable Intelligent Controller**, the "HI-Q" Series will perform to specifications in the oceans, on earth or in outer space, in the Alaskan tundras or in the Tucson deserts.

MILITARY, NUCLEAR, SEISMIC & EPRI TR-102323R3 models are (or being) approved. Contact OTEK™

Where Are the "HI-Qs" Being Used?

Only OTEK's HI-Q Series are in outer space (**Mir & I.S.S.**), military aircraft (**night vision**), naval warships (**Mil-Spec**), nuclear power plants, offshore exploration/drilling, mass transit (**Metro**), biomedical (non-life support), pharmaceutical, agricultural, waste & water treatment, etc.

IS YOUR APPLICATION MORE CRITICAL?

IF YOU DON'T SEE IT, ASK FOR IT!
Our customers **THINK** of the products; we just design them!

B

HI-Q SERIES COMMON ELECTRICAL SPECIFICATIONS FOR:

For HI-Q: •DIN-BAR •TEK •TBS •114 •214 •116 •117
•118 •119 •120 •121 •123 •124 •126 •127 •219 •2K and 2000

(All at 25°C) Also See Individual Specifications

SERIAL COMMUNICATIONS (DIGIT 2)

- Isolation to 5V or Other Power Inputs: 500VDC
- Baud Rate: to 19.2K Baud
- Protocol: Full ASCII
- Concurrent Use (Translator) of USB or RS-232C & 422 or RS-232C & RS-485 I/O & USB

NOTE: As a translator, you can use the com. port to translate from one protocol to another, so long as you only "talk" on one and listen on the others, ie., talk on USB, listen on 485, or 422, talk on 232, listen on 485. Can NOT have 232&USB.

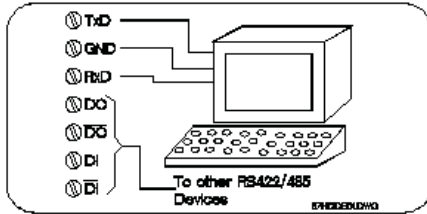

POWER INPUTS (DIGIT 3)

- 5VDC±5% Non-Isolated
- Or 10-32VDC (24VAC) Isolated
- Or 90-265VAC or (100-300VDC on request) Isolated
- Power consumption varies from model to model and number of options selected. See Specific Models.

ON-OFF CONTROL OUTPUTS RELAYS (DIGIT 4)

- Type: S.P.D.T. (1C)
- Max. Switching Current: 10A Res.
- Max. Switching Voltage: 30VDC/240VAC@Rated Current
- Contact Protection: Included
- Contact Isolation: 1000VRMS
- Initial Contact Resistance: 0.1Ω
- Life Expectancy: 10,000,000 Cycles

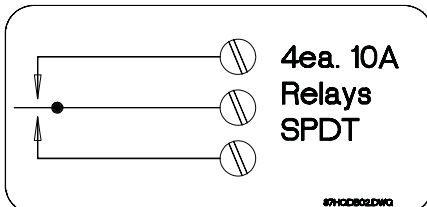

BiMOS OPEN COLLECTOR

- Type: Sink Driver (Transistor)
- Isolation to 5V Power: None
- Max. Current Sink: 250mA
- Vsat @250mA: .8V
- Standard VC: 5VDC
- External VC: <35VDC
- Switching Speed: 1μS

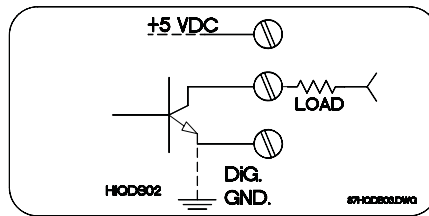

ANALOG CONTROL OUTPUTS (DIGIT 5)

- Accuracy & Linearity: ± 0.01% F.S.
- Resolution: 16 Bits
- Outputs: 0-5VDC(>100KΩ), 4-20mA (<1KΩ)
- Custom Output: 0-20mADC
- Compliance Output: 30VDC
- Isolation: 500VDC

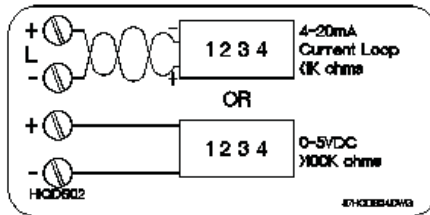

MEASURING INPUTS (DIGIT 6 & 7) DIGITAL DISCRETE INPUTS Functions Selectable:

Event, Timer, Period, Frequency, RPM and SPH

C

Multilevel (Option 01): (Low Speed)

- Dry Contact to 24VDC
- Isolation to 5V Power: None
- Response: DC to 100Hz
- Input Impedance: 1MΩ/27pF

TTL Level (Option 02):(High Speed)

- 0<.8V; 1=>2.4V
- Response: DC-50KHz
- Isolation to 5V Power: None

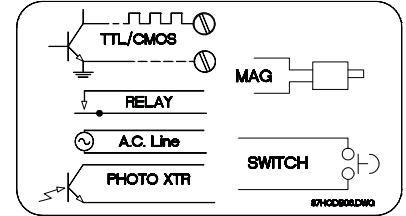

ANALOG INPUT SIGNALS

(All Isolated to 500VDC & After 30min. Warm Up)
Note: Worst case accuracy & linearity are the sum of A/D and selected signal conditioner errors.

A/D CONVERTER

- 16-Bit Plus Sign A/D(50K Counts)*
- Display Resolution:±0.002% of F.S.*
- Accuracy: ±0.01% of Full Scale
- Linearity: ±0.01% of Full Scale
- Drift: ±50PPM/°C
- Zero: Automatic/Programmable
- SPAN: Programmable
- F.S.Input Voltage Range: ±0.5VDC
- Max.Current Range: ±1/2 AmpDC
- Sampling Rate:16/sec. ÷ by Channels
- Input Type: Single Ended/Diff.
- Input Bias: 50pA
- C.M.V.: ±2VDC
- CMR: >90dB
- Averaging (Weighted): None to 40
- Input Impedance: See Ord. Info.
- * Note: Limited by display of model selected (# of digits)

COMMON ELECTRICAL SPECIFICATIONS FOR: (Continued)

**For HI-Q: •DINBAR •TEK •TBS •114 •214 •116 •117
•118 •119 •120 •121 •123 •124 •126 •127 •219 •2K and 2000**

NOTE: All V/mA Input Models (Options 10, 11, 14, 15, 30, 31, 33, 34, 35, 36, 50, 51, 53 & 54) Have Internal Jumper Selected Input Ranges of .5, 5, 50 & 500V and .5, 5, 50, 500mA.

OPTIONS: (See Ord. Information) 10, 11, 12, 30, 31, 32, 50, 51 & 52

* Same Specifications As A/D

ANALOG SIGNAL CONDITIONERS

(All outputs set for ±500mVDC F.S.)

STRAIN-GAGE:

(Options 17, 18, 37 & 38)

- Accuracy and Lin.: ±0.1% of F.S.
- V Excitation(1): ±2.5VDC ±0.5%
- I Excitation(2): 1mADC ±0.5%
- Stability of Excitation: ±0.05%/°C
- Maximum Current of VE: 30mA
- Maximum Voltage of IE: 5VDC
- (1) Typical for S-G of 200-400Ω
- (2) Typical for Monolithic S-G to 5KΩ
- (3) Tare, Range, Zero Span Are User-Programmable

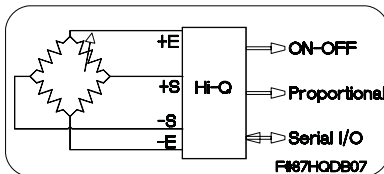

VDC (Options 25 & 47)

- Accuracy & Lin.: ±0.1% of F.S.
- Full Scale Input: ±10mVDC
- Typical Gain: 50(see A/D Sec.)
- Common Mode Voltage: ±2VDC

RESISTANCE (Options 20 & 40)

- Accuracy & Lin.: ±0.1% of F.S.
- Full Scale Input: 50KΩ
- Excitation Current: 0.01mA
- Stability of Excitation: ±0.05%/°C

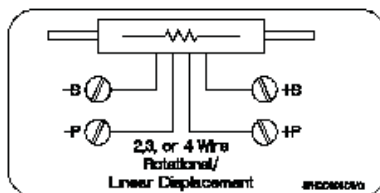

TRUE RMS VOLTS, AMPS & WATTS

(Options 14, 15, 34, 35, 36, 53, 54 55 60 & 61)

- Accy. & Lin.: ±1.0% of F.S. DC-50KHz Sine Wave
- Accy. & Lin.: ±0.5% of F.S. DC-10KHz Sine Wave
- Accy. & Lin.: ±2.0% of F.S. 10KHz- 50KHz Sine Wave
- Resolution: ±0.01% of F.S.
- Common Mode Voltage: 2Vrms
- Overvoltage Protection: 500VAC
- Overcurrent Protection: 200%
- Input Impedance: See Ord.Info.
- Drift vs Temperature: ±50 PPM/°C
- Input Bias Current: 10pA

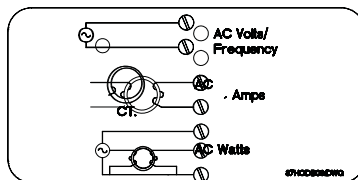

RTD (Options: All RTD)

NOTE: Due to limited signal input connections (6) we can accept 2-wire/3 channel; 3-wire/2 channel or 4-wire/1 channel. Contact Otek for others.

- Din ($\alpha=0.00385$): -200° to +800°C
- ANSI ($\alpha=0.003923$): -200 to +600°C
- Accuracy: ±0.1°C of signal
- Resolution: ±0.1°C of signal
- Scale: User Selectable °F, °C or °K
- Linearization: Polynomial to 9th
- Open Sensor: +Overrange/Flash
- Connections: 2,3 Wire (4 Wire On Request)
- Excitation: 0.1mA or 1mA (Cu)
- Open RTD: Burn-up
- PT200, 1K & 2K on request

THERMOCOUPLE (Opt. 22, 42 & 56)

- Thermocouple Type: User-Selectable but Specify When Ordering (J, K, T, R, S, B, C, E)
- Accuracy of HI-Q: ±0.1% of F.S.
- Resolution: 0.1°
- Full Scale: Same as Thermocouple
- Open TC: (Burn Up)
- Input Impedance: >100MΩ

- Scale: User Selectable °F, °C or °K
- Lead Resistance Effect: <0.001°/100Ω
- Linearization: Polynomial to 9th

Notes:

1. No isolation exists between channels.
2. **Do not use** grounded thermocouple.

OTHER INPUT SIGNALS: 3 & 4

wire RTD, pH, ORP, % RH, Speed, RPM, Volume, Flow, High Speed Peak & Hold, etc.

ENVIRONMENTAL (To Specs) **INDUSTRIAL & NUCLEAR:**

- Operating Temperature: -10-55°C
- Storage Temperature: -20-65°C
- Humidity: 10-90%RH, N.C.
- MTBF: >200,000HRS (Calculated)
- NEMA4X(IP65)

MILITARY: TO SPECIFIC MIL-STD (I.E. 461, 462, 901, 810 F, 167, ETC.)

Nuclear: Class 1E, EPRI, TR-102323, NUREG 0700 & 0800

CUSTOMS: OTEK CUSTOMIZES ANY OF ITS PRODUCTS TO YOUR EXACT SPECIFICATIONS.

POWER CONSUMPTION (WORST CASE)

DIN-BAR	5W
HI-QTBS:	10W
HI-QTEK:	15W
HI-Q114:	10W
HI-Q214:	10W
HI-Q116:	10W
HI-Q117:	15W
HI-Q118:	15W
HI-Q119:	15W
HI-Q120:	15W
HI-Q121:	15W
HI-Q123:	5W
HI-Q124:	5W
HI-Q126:	10W
HI-Q127:	5W
HI-Q219:	10W
HI-Q2000:	15W
HI-Q2K:	15W