

NEW TECHNOLOGY™ TRANSMITTERS 4-20mA TRANSMITTERS MASTER CATALOG

**NT™
SERIES**

January 10, 2017

NOW 10CFR50 APP. B & 10CFR21

Manual/Serial/Signal

() = Model Number

Manual/Serial/Signal

Panel Mount



(NTT) 3x6x1"

FEATURES:

- *Input/Output Fail Alarm
- *AC/DC Signal or Universal Power
- *Isolated Serial I/O & Flash Memory
- *Manual, Serial or Signal Controlled Output
- *>9 Models, 30 Input Signals
- *Nuclear Class 1E, Mil-Spec, Industrial Grades
- *Customs Welcome

Panel Mount



(NTS) 1x6x2"

INDEX:

The Housings.....	Page 1
The New Technology.....	Pages 2-3
Common Electrical Specifications.....	Page 3
Models: Descriptions, Features & Limitations.....	Page 4
General Option Descriptions.....	Pages 5, 11, 12
Input Signal Specifications.....	Pages 6-11
Ordering Information.....	Pages 13-14
Mechanical and Mounting.....	Pages 15-18
Portable Transmitter/Receiver/Calibrator-Model 420.....	Page 19
New Technology Award.....	Page 20

DIN-Rail Mount

(NTI)

Dual Loop Isolator/
Controller

**UNDER
DEVELOPMENT**

COMING SOON!



4-20mA Transceiver,
Calibrator & Meter
MODEL 420

Portable



- *Buy Direct From OTEK
- *Eliminate Reseller & Save ~50%
- *Talk Directly to our Engineers and Sales
- *Get our Lifetime Warranty!

(NTB) 1/8 DIN

Panel Mount



DIN-Rail Mount



(NTY)

(NTX EXPLOSION PROOF)

Pipe/Wall Mount

4" Cube



IM2
Exd1, Class
1, Div 1

Ex &
ICE ex

(NT0) 1/8 DIN
Panel Mount



-1-

520-748-7900

FAX: 520-790-2808

E-MAIL:sales@otekcorp.com

http://www.otekcorp.com

**OTEK™
CORP.**

SINCE 1974

Catalog of 1/10/17

4016 E. TENNESSEE ST.
TUCSON, AZ. 85714 U.S.A.

MADE
IN
USA



BENEFITS:

- *No Shock/Vibration Sensitivity
- *Auto Tri-Color Bar & Digital Display
- * Input Signal & Output Failure Detect & Alarm
- *Isolated Serial I/O (USB/RS485)
- *Remote Controller for Scada/DCS
- *Self Diagnostics
- *Manual/Automatic/Serial Controlled 4-20mA Output
- *Math Functions-Polynomials, X-Y Tables
- *Isolated Relays/Transistors Out
- *Universal Power Input (DC & AC)
- *100% A.C. Signal Powered For V/A/W/ Hz 90-140 VAC Lines
- *Ethernet-µSD Memory Card (On Request)
- *Lifetime Warranty

How Does OTEK's New Technology Differ?

We use: ultra-efficient (approaching O' LED) LEDs, nanotechnology ASIC, high efficiency power management techniques, state-of-the-art software that has been verified and validated (SV&V), monolithic transformers for greater accuracy and isolation, our patented loop power technique, signal failure detection-alarming, patented A.C. signal powering technique, ASIC DAC with galvanic isolation and opto-isolated relay drivers. We also offer OTEK's exclusive LIFETIME WARRANTY!

DESCRIPTION

The NT Series is a variation of our award-winning and patented NTM & UPM series, which feature auto tricolor displays and can be used as DPMs, Timers, Counters and Totalizer Meters or Controllers. All models use the same hardware which has been 100% approved for Nuclear Class 1E (safety), MIL-SPEC, Aerospace standards and the software has been SV&V certified. With the NT Series, you are assured a product worthy of your trust and confidence at a reasonable price. The modular firmware and hardware construction of the NT, along with high-quality multi-source componentry increases the unit's life expectancy (>40 years required by MIL-STD) and reduces obsolescence (>30 years required by the nuclear industry).

Signal Fail Alarm: Otek's patented technology detects when the input or output signal fails so you know that your load is not connected. It flashes its display "input FAIL" or "output FAIL," blanks the bargraph and transmits isolated serial data post mortem for ~ 30 seconds.

Trend Indication: Its automatic tricolor (R/Y/G) bargraph changes color based on programmable set points (4) to warn operators of **safe, caution or danger** limits (like a traffic light).

Output: The isolated 4-20mA has a range of 3-23mA and it's 30VDC compliance can drive up to 1K Ohm total loads.

Input Power: The NT accepts 5-32VDC or 90-265VAC power input and even USB/Ethernet powered on request. High efficiency keeps the power consumption under 1 Watt without relays, and under 2 Watts when relays operate.

Manual Control (Direct/Reverse Output): Some applications require reverse acting output. The standard is "Direct" (clockwise to increase the current).

"Reverse" means counter-clockwise increases the output. All else is the same.

MODEL CASES (Digit 3)

NT0: Plastic or metal case; 1/8 DIN **horizontal** panel-mount version. All connections are on the rear.

NTB: Plastic or metal case; 1/8 DIN **vertical** panel-mount version of the NT0. All connections are on the rear.

***COMING SOON: NTC:** 1x1x0.6" Transmitter module: We make this item available for your OEM application. This is the same module we use in all our NTM, UPM and NT series and it comes ready to plug in. All you need is power (>7<32VDC at 25mADC) and signal, or even serial (USB or RS485) and "trim" pots for 20mA output, unless you want to program it serially for span, offset, tare, square root or any of the other available mathematical functions.

NTI (Plastic Case): Standard DIN-RAIL mount (1" wide). Available in 1 or 2 channel, 100% isolated, loop/signal or external power.

NTT (Metal or Plastic Case): Panel mount only (3x6x1" deep), with large 0.6" digits and 4" long tricolor bargraph. The NTT can be ordered with built-in high resolution single turn potentiometer for quick manual setting of the 4-20mA output and it can be set for direct output (supply) or reverse output (demand) action. A nuclear favorite!

NTS (Plastic Case): This is the **SLIM** version of the NTT at only 1" wide (1x6x2" deep); all other features are the same as the NTT except the NTS is only available in a plastic case. Like the NTT, the NTS offers an optional built-in manual control potentiometer.

NTX (Explosion Proof Case Only): Top of the line for hazardous and life protection applications, the compact (4x4x3") explosion proof housing is certified for Class 1, Div. 1, Groups B-G; EX & IECex: IM2, Exd1, and it even includes relays for emergency shut down!

NTY (Plastic Case): DIN-RAIL mount (1.75" Wide) with front bar-digital display and front connections for all I/O. Ideal for operator in-situ calibration, programming & verification of process performance.



INDUSTRIAL GRADE COMMON ELECTRICAL SPECIFICATIONS

Input & Display: See Below For Input Signals:

- * A/D: Accuracy, Linearity & Resolution: +/- 0.05% of F.S, ± 1 digit. 12 Bits, Sampling: 40/sec; Averaging: 0-255, zero, span, offset, tare, math functions and 25 point X-Y tables & polynomials.
- * Bargraph: 51 Automatic Tricolor (R/Y/G) Segments (4" or 2" Long)
- * Digits: Four Full Digits (9.9.9.9 & -1.9.9.9).
- * Typical Power Consumption of Display: 10-100mW@3.3V-5V.
- * Temperature Coefficient: +/-50PPM/°C
- * Operating Temperature: -10 to +60; Storage: -20 to +70°C
- * CCMR: >90dB@50-60Hz
- * Isolation: >500VDC to any other I/O & P.S.
- * Humidity: 5-95% RH non-condensing
- * Front Panel: NEMA 3. NEMA 4X on request (some models).
- * Failed Signal Detect: When output opens, the bargraph will turn off and the digits will flash *OUT OPEN* and this message will be serially transmitted with date and time stamp.

Note 1: E and M grades are the same as Industrial unless otherwise specified.

THE POWERFUL A.C. POWERLESS™

Yes! You can have the NT powered by the input signal and have controlling outputs such as relays, O.C.T. & analog output!

How it works: Your input signal (Digit 8 & 9, options 01-04, 16 & 17 only) powers the display, CPU, serial I/O and isolators. Your external power source powers the outputs (relays and/or analog out).

Benefit: You have two independent and isolated sources (fail safe).

Requirement: Your signal must produce >10mW (current loop, VDC, VAC or AAC) and sustain <4V burden. If not, use external power (options 33-44 on Digits 8 & 9).

AC Signal Power & Outputs? Yes, you can have input options 01-04, 16 or 17 (digits 8 & 9) and relays (2 maximum) without external power!

Requirements: VAC input must be >90<140VAC/DC, and AAC input must be >3<5 AAC via C.T. or a V & A (Watts) combination of >100<700 watts. Ideal to monitor and control 120VAC mains! Contact OTEK for details.

Zero & Span: Since the NT requires NO recalibration, the zero & span potentiometers are internal (on some models). If required, you can change them via the serial port. See pages 6 & 7 for standard scale plates.

NT SERIES: TRANSMITTER BLOCK DIAGRAM

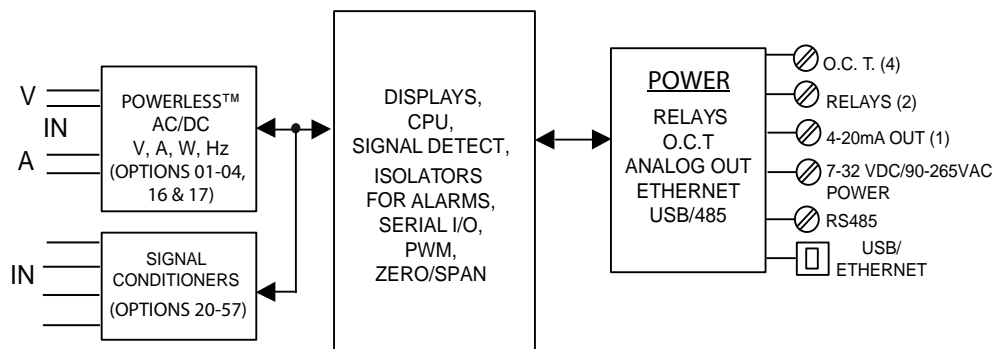

-3-



The NT Series offers eight packages designed to meet most needs of the industry. Due to size, some models have limitation on the available functions (options). Please contact Otek for customization.

NT0: 1/8 DIN Panel Mount: (Horizontal)



Models NT0 and NTB

Features: Compact plastic or metal case, also available to MIL & Nuclear grade for EMI/RFI, surge susceptibility, shock, vibration & environmental. Only 3.55" (90mm) x 1.78" (45mm) x 2.75" (68mm). Standard panel cut out of 3.62" x 1.85 (92x 46mm).

Limitations: Single channel; no internal potentiometer for manual control.

NTB: 1/8 DIN Panel Mount: (Vertical)



NTI: DIN Rail Mount: Single/Dual Channel

Features: 1 or 2 channel; all connections on front; displays either two 100% isolated inputs or input & output; ideal for retransmission and upgrading 10-50mA to 4-20mA loops without any wiring changes.



Limitations: No bargraph; no relays or O.C.T. available; plastic case only; no internal potentiometer for manual control. See NTM-1, -2, -6 or -9 for dual channel models with all features included.

NTS: Slim-Only 1"W X 6" H: Panel Mount

Features: Ideal for tight spaces: only 2" deep; internal potentiometer for optional manual/auto control, 4" (100mm) high bargraph.

Limitations: Plastic case only; single channel; vertical mount only (see NTM-H for horizontal mount). Ethernet on request only.



NTT: 3x6x1" Panel Mount

Features: Large 0.6" digits, 4" long bar, only 1" deep behind panel; internal potentiometer (optional); metal case to MIL & Nuclear Class 1E or plastic case.

Limitations: No relays or O.C.T.; single channel (see NTM-5 for up to 4 channels). Ethernet on request.



NTX: Explosion Proof

Features: Certified for Class 1, Div 1, Groups B-G, EX & IEx; Im2, Exd1; pipe (3/4 NPT) or wall mount, IRDA I/O, circular bar.

Limitations: Metal Only; single channel; only 2 relays, no internal potentiometer for manual control; no ethernet (contact Otek for custom).



NTY: DIN Rail Mount

Features: Most versatile package for DIN rail mount, all features available, except:

Limitations: No internal potentiometer for manual control; plastic case only; only 2 relays, single channel. Ethernet on request.



420: Portable Calibrator

Features: Ideal companion for any and all 4-20mA current loop applications. It's a transmitter for calibration for meters/receivers and also a receiver for calibration of transmitters; it can sustain burden of up to 1,000 Ohms. It's powered by a 9 V battery.

Limitations: See page 19 of this catalog for the data sheet specifications.



NTC:

UNDER CONSTRUCTION



DIGIT 4, 4-20MA OUTPUT CONTROL & MODE:

The NT series offers 5 modes of control (see ordering information on page 13).

Option 0, Retransmission: Driven by your input signal: 0-Full Scale [F.S.]=4-20mA=4.0-20.0mA out or custom calibration.

Option 1, Manual: Via internal front panel potentiometer **direct** action.

Option 2: Same as option 1, but with **reverse** action. Note: Only model NTS & NTT offer a built-in potentiometer. All others are externally mounted 10K pot. and are **NOT** included (see option 3).

Option 3, Manual External Control: All of the NT Series can be ordered with manual (potentiometer) external control, but the input signal Option 56 (10K Resistance) must be specified on Digits 8 & 9.

Option 4, Serial Input Control: Now you can control your process via your DCS/SCADA/APP via isolated USB or RS485 (ethernet on request). Use option 4 on Digit 4 and option 58 on Digits 8 & 9.

Option 9, Custom: Contact Otek for your specific needs.

NOTE: NEVER apply power to the NT without the 10K potentiometer installed or inputs shortened. Replace the jumper with your potentiometer before powering!

OPTION 3: ANALOG OUTPUTS

⊗ + LOOP OUT

⊗ 0V/-LOOP



EXTERNAL
MANUAL
CONTROL

DIGIT 4: MANUAL CONTROL:

OPTION 4: SERIAL INPUT CONTROL

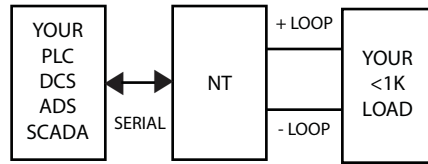

DIGIT 5, SERIAL I/O & MEMORY:

Settings: 8N1N, 1200-19,200 Baud, ASCII.

Option 0, USB: Complies 100% with V2.0 and if digit **10**, option **1** is selected (USB powered) then digit **5** must be option **0**.

Option 1, RS485: Complies with industry standard and will require 5VDC@<3mA and a terminating 330 Ohm resistor at first and last unit in the BUS.

Ethernet: On request.

DIGIT 6, GRADE:

Industrial Grade (Options 0 or I) is per these published specifications. Grades **M** and **E** per agreed specifications. Options **E** & **M** typically include an EMI/RFI shield all around and filtered connectors to meet EPRI-TR-102323-R3 for Class 1E (requiring ~2" deeper case). OTEK will build to certain nuclear or MIL-Standards but testing and confirmation of compliance, if required, will be quoted extra. Option **0** is 94VO plastic, option "I" is an aluminium nickel plated case and cover; bezel face has black powder coat finish to Mil-Specs. The back cover is either black plastic or nickel plated aluminum. Typical Mil-Specs: 461, 462, 169, 901, 801, RTCA-160, I EEE344, etc. Contact Otek for custom colors. E grade to Class 1E (Nuclear).

DIGIT 7, NUMBER OF CHANNELS:

Only model NTI offers 1 or 2 channels. All others are single channel. For multiple channels (1-4), see our NTM series or contact Otek.

Other Important Data:

Math Functions: +, -, x, ÷, √, Polynomials to 9th order, 25 Point X-Y table, zero, offset, span and tare. You can add, subtract, multiply, divide (etc.) one channel to/from another channel and display the result in the other channel (i.e. V (Ch.1) xA(Ch.2)=W(Ch.3)).

Output Failure Alarm: Requires approximately 1 minute of normal (mid-scale) operation for it to alarm the display and output the serial data after the signal (Powerless™) has ceased (post mortem).

PID: Programmable (best with >dual channel model NTI) automatic or manual with external 10K Ohm potentiometer (option 56).

Watch 1 minute video: [YouTube](http://youtu.be/WXi970VXIzM)
<http://youtu.be/WXi970VXIzM>

(Model NTX)



NTX: Certified for Class I, Div. 1, Groups B-G; EX & IECex: IM2, Exd1.



Note: You can change factory standard calibration via the serial port.

DIGITS 8 & 9, INPUT SIGNAL CONDITIONERS:

Please see page 14 for listing of standard input signals accepted and contact Otek if yours is not listed.

See the next section for input descriptions.

Note: Otek's exclusive Input/Output Fail detect (open) is standard on all models. Use option 29 and specify if you want it disabled.

NEW A.C. SIGNAL POWERED!

Note: Must use P.T. and C.T.!

Options 01-04, 16 & 17 under the Input Signal (Digits 8 & 9) are designed to allow the NT to monitor, control and transmit the normal operating range of household power lines without the need for power input. It is powered by your signal. See pages 7 & 8.

Important Note on A.C. Powerless

The NTM, UPM & NT Series can extract energy from your A.C. signal to power itself and opto isolated serial, optional O.C.T. (Digit 11, option 1), and to power the 4-20mA output (Not 20-4mA out) from a wide input range (see specifications next). External power is required to power the optional relays (Digit 11, option 2) (200mW each). If you need relays, either use the external powered options on Digits 8 & 9 (30-44) and the Digit 10 power input options (1-4) or use Powerless™ options 01-04 on Digits 8 & 9 and Power Input option 09 (custom) on Digit 10 and specify (09=Power for relays and DAC). Result: The signal will power the instrument and will include our patented **Signal Fail Detection & Alarm**. The relays and analog output are powered by the external power option (all 100% isolated).

Minimum Signal Power: The current loop requires ~1/2W and each relay, another 1/2 W of signal power. If the current loop is at max out (20mA) and a relay is "On," your signal must be able to supply >1Watt! If it cannot, contact Otek to discuss custom options, or use external power (options 30-44).

Note on A.C. Signal Power 4-20mA Out:

The 4-20mA output is NOT isolated from the signal input. You must use a **P.T. & C.T.** for input options 01-04 or 16 on Digits 8 & 9 and option 0 (None) on Digit 10 (Power Input); otherwise use input options 33-44 or 57 on Digits 8 & 9 with any option 1-4 on Digit 10.

Output Specifications:

Accuracy: ±0.1% of F.S. of Signal

Linearity: ±0.2% of F.S. of Signal

Min/Max Load: 0-200 Ohm

Protection: Short Circuit

Isolation I/O: **None. Must use C.T. and/or P.T.**

Note: Options 01-04, 16 & 17 are powered by the signal they measure. No signal=no display or transmission. They are intended to monitor-control-alarm operating power lines. If not acceptable, use "Powered" options 33-44 or 57.

(NTT) 3x6x1"

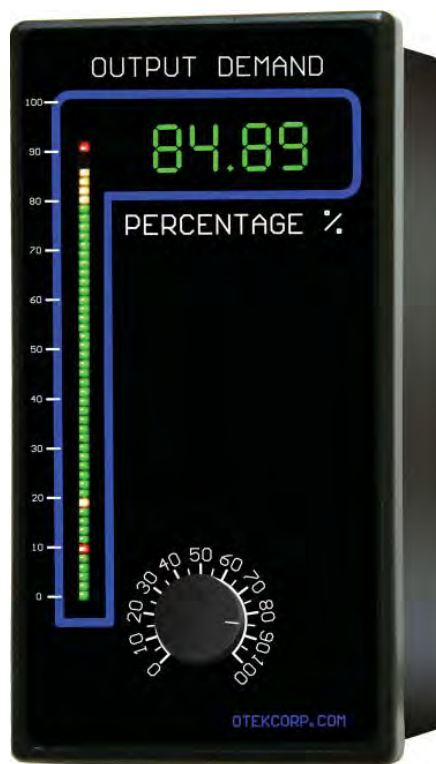

A.C. SIGNAL POWERED

VAC SIGNAL POWERED

Digits 8 & 9, Option 01

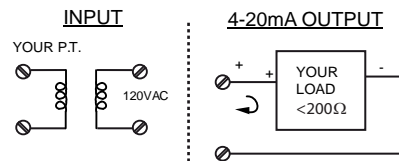

NOTE: You must use **120V P.T.**
RANGE: 90-140VAC

A.C. VOLTS & HERTZ

(Range: 90-140VAC)

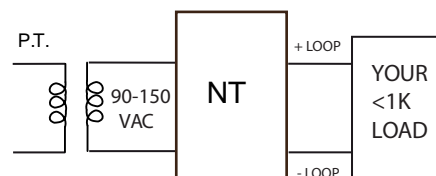

Calibration: (.154mA/V): 90V in: 3.85mA;
120 V in: 18.48mA

Display: 90.0 -140.0 VAC

STANDARD NT SCALE
(Option #01)
115-125 V Line

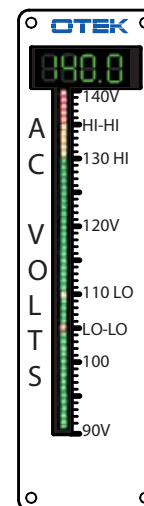

Note: You can change factory standard calibration via the serial port.

A.C. SIGNAL POWERED

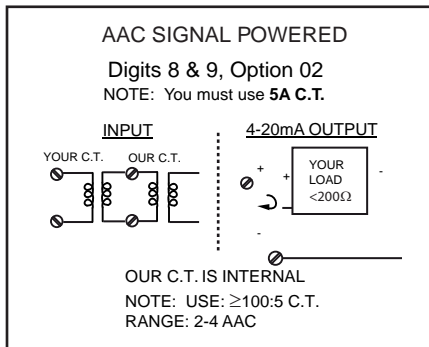

A.C. AMPS

(Range: 2-4 AAC)

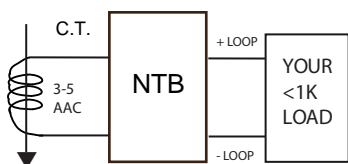

NOTE: BEST IF C.T. IS $\geq 100:5$ RATIO

Calibration: (4mA/A): 2A in: 8mA; 5A in: 20mA

Display: 0.0 - 5.0 Amps AC

STANDARD NT SCALE
(Option #02)
AMPS

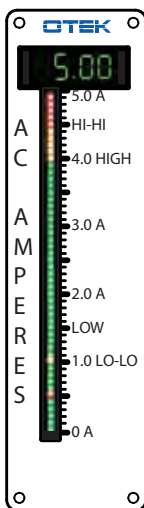

Note on Our Current Transformer: Standard operating range on our internal C.T. is 1-4AAC, 50/60 Hz. 5 Amps is absolute maximum for under 5 minutes.

A.C. SIGNAL POWERED

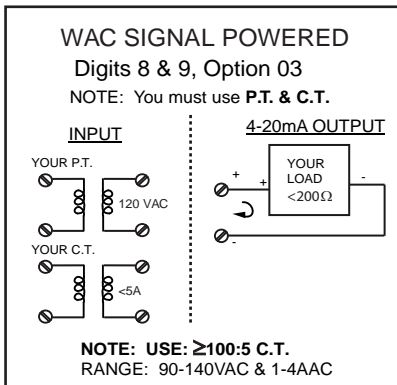

A.C. WATTS

(Range: 60-560W)

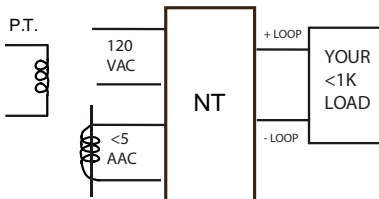

Calibration: (0.03mA/W): 133.3W in: 4mA out; 480W in: 14.4mA out. 600 Win: 20.0mA out or custom calibration.

Range: 60-140VAC & 1-4 AAC (60-560 W)

Display: 100-600 Watts

STANDARD NT SCALE
(Option #03)
WATTS

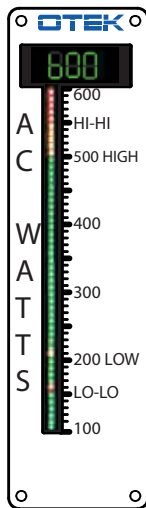

A.C. SIGNAL POWERED

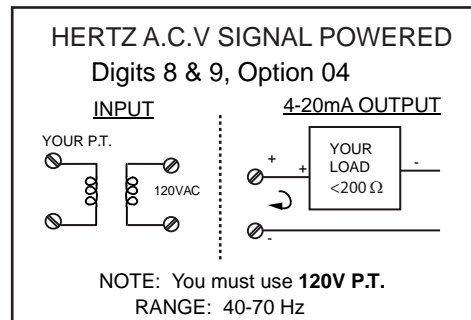

A.C. VOLTS & HERTZ

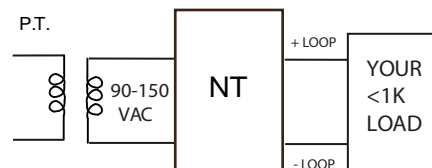

Calibration: (0.3mA/Hz): 40 Hz in: 12mA; 60 Hz in: 18mA; 66.6 Hz in: 20mA

Display: 4.0-20.0mA Out

Standard NT Scale
(Option #04 {09})
50 HERTZ

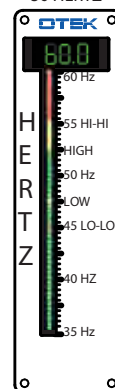

Standard NT Scale
(Option #04 {09})
40 HERTZ

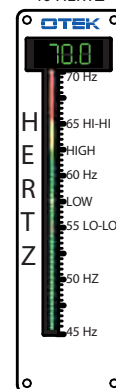

Standard NT Scale
(Option #44 {09})
400 HERTZ

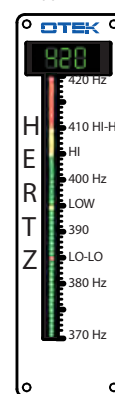

INPUT SIGNAL SPECIFICATIONS (Digits 8 & 9): Continued

Note: You can change factory standard calibration via the serial port.

Option 16: 7-140 VAC/DC: Signal power transmitter for direct connection to signal. Your signal must produce >250mW of power.

Now you can monitor/control your emergency power generator and battery bank. Just monitor its output and control its input.

Range & Calibration: 7.0-140.0 RMS (AC or DC) Input=0.0-100% & 4-20mA Output

Accuracy: ±0.5% of F.S.

Option 17: 10-50mA C.L. Powered: Now you can convert old obsolete 10-50mA current loop to standard, isolated 4-20mA without wiring changes or extra equipment.

Calibration: 10-50 in=4-20 out

Accuracy: ±0.1% of F.S.

Recommendation: Use NTI with 2 channels; 1 for input (loop powered) and 1 for output (external powered) to confirm the exact input/output integrity. It is 100% isolated.

EXTERNAL POWERED OPTIONS (Digits 8 & 9)

Option 20: 4-20mA: The burden on the loop is only 0.5V @20mA (25 Ohm) and you can use the math functions for converting to flow, instantaneous or totalizer (volume).

Accuracy: ±0.1% of F.S.

FIG. 20: 4-20mA

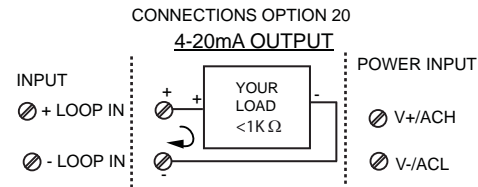

Calibration: 4.0-20.0mA in=0.0-100.0% → 4.0-20.0mA Out.

Options 21-24: VDC: Input impedance is 1 Mega Ohms on all VDC ranges.

Accuracy & Linearity: ±0.1% of F.S.

FIG. 21: VDC OPTIONS 21-24

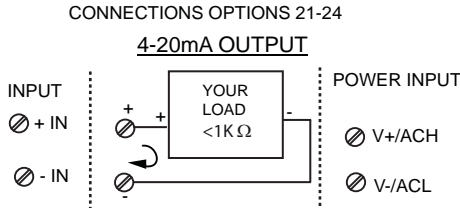

Calibration: 0.0-100.0%=0-F.S.=4.0-20.0mA out.

Options 25 & 26: 10mADC/100mADC: Since the NT is 0.5V full scale (1,000 Counts) the "Shunt" resistor used is 50 Ohm for 10mA or 5 Ohms for 100mA.

Accuracy & Linearity: ±0.1% of F.S.

FIG. 25: mA DC

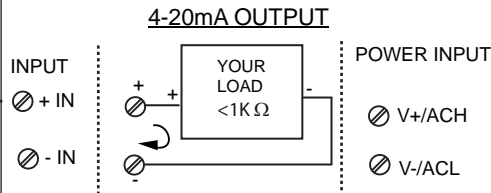

Calibration: 0.0-100.0%=0-F.S.=4.0-20.0mA out.

NEED BARGRAPHS/METERS?
See our **NTM**
(New Technology Meter)



Options 27, 28, 38 & 40: AC or DC Watts: We use a dual channel true RMS-DC converter to give you the highest accuracy.

For DC signals (Options 27 & 28), both inputs (A & B) are scaled for 0-1VDC and have internal provisions for voltage dividers/shunts for up to 100V/100mA inputs. Note: Our RMS-DC converter accepts both AC & DC signals.

For A. C. low voltage Watts, option 38 accepts up to 1VAC at both inputs. Easily scale-able to higher voltages with external divider, or use a higher input range.

Option 40 accepts the industry standard 120V P.T. & 5A C.T.

For other inputs, use option 29 and specify or see our NTM Series for A.C. signal powered equivalent.

Accuracy & Linearity: ±0.1% of F.S.

FIG. 27: WATTS RMS

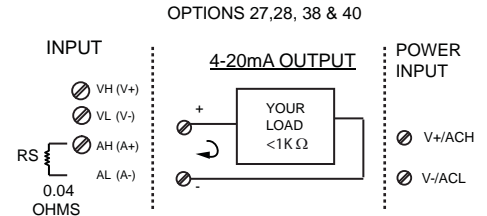

Calibration: 0.0-100.0%=0-F.S.=4.0-20.0mA out.

Option 29: Custom: Use this option to describe any custom input, scale or modification to the NTY and contact us for feasibility and cost.

(NTB) 1/8 DIN



Note: You can change factory standard calibration via the serial port.

**INPUT SIGNAL CONDITIONERS,
DIGITS 8 & 9:**

Options 30-36: V, mA Amps RMS:

Here we use a **True RMS-DC** Converter for accurate ($\pm 0.1\%$) measurement of sine waves up to 10KHz. For 10-20KHz and SCR fired to $\pm 1\%$. Input impedances vs. range are the same as for VDC & mADC ranges.

Accuracy & Linearity: $\pm 0.1\%$ of F.S.

FIG. 30: V/A RMS

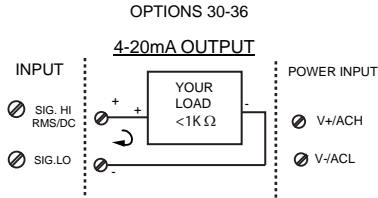

Calibration: $0.0-100.0\% = 0-F.S. = 4.0-20.0\text{mA out.}$

Option 37: 5 Amps AC:

Specifically for external current transformers (**C.T.**) this option requires an externally mounted (supplied) 0.04 Ohm, 0.1% 20 Watt resistor. You can mount the "Shunt" at your **C.T.** or at the NT connector, but make sure the connections are "Perfect" to electrical codes. The C.T. might have "**Lethal**" **High Voltage** without a "Shunt" (Open). See OTEK's NTM Series for **C.T.** powered instruments (Patent # 7,626,378).

Accuracy & Linearity: $\pm 0.1\%$ of F.S.

FIG. 37: 5 AMP AC

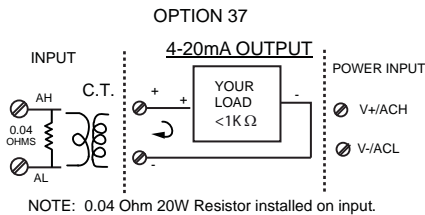

Calibration: $0.0-100.0\% = 0-F.S. = 4.0-20.0\text{mA out.}$

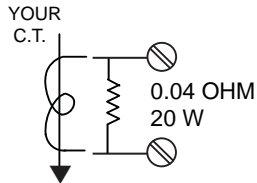

Options 41-44: Frequency Input:

We use an **F-V** to accept frequencies up to 20KHz and amplitudes from 1-400V peak or dry contact or open collector transistor (O.C.T.). For 50 to 440 Hz power line frequency measurement, use Options #43 or #44.

Accuracy & Resolution: $\pm 0.05\%$ of F.S.

FIG. 41: FREQUENCY

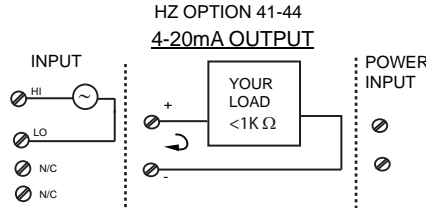

Calibration: $\text{Zero-F.S. in} = 0.0-100.0\% = 4.0-20.0\text{mA out.}$

Option 45: Strain-Gage ($\geq 300 < 4\text{K Ohm}$):

These are typically "Monolithic" **S-G** that require constant voltage (preferably) excitation. We use 4.096V for high stability and accuracy. Use option 29 and **specify** your S-G sensitivity and the NT display at Zero and Full Scale.

Excitation: 4.096V, 50 PPM/°C

Range: $>120 \Omega$

Accuracy & Linearity: $\pm 0.1\%$ of F.S.

Note on S-G: Some S-G offer $\pm 1\text{VDC}$ or 4-20mA condition output. Use Option 29 and specify.

FIG. 45: S-G

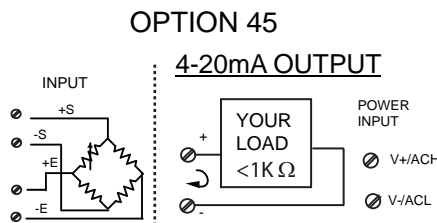

Calibration: $\text{Zero-F.S. in} = 0.0-100.0\% = 4.0-20.0\text{mA out.}$

Option 47: RTD (PT100): We excite your 2, 3 or 4 wire RTD with 200μA to avoid the "self heating" effect. The range of the NT is the same as your **RTD** typically -200°C to $+800^\circ\text{C}$ ($-328 + 1562^\circ\text{F}$). You can place the decimal point at will (typically -200.0 to 800.0). The **PT100** has a temperature coefficient of 0.00385 Ohms/Ohm/°C. (For legacy 0.00392 TC (known as ANSI 392) or PT 200 (200 Ohm), or 10 Ohm copper RTD, contact **OTEK** and use Option "29".

Note: You can change °C (standard) to °F and RTD type via serial port. Default is °C.

Accuracy & Linearity : $\pm 0.1\%$ of F.S. plus sensor's error.

Note: For 2 wire, jump -S to -E and +S to +E. For 3 wire only jump -S to -E.

FIG. 47: 2, 3 or 4 WIRE RTD

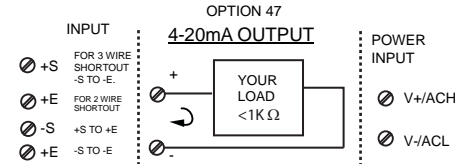

Calibration Direct Reading: $-200-800^\circ\text{C} = 4-20\text{mA out.}$

Option 48: RTD (PT1000): Same as PT100 except it is 1000 Ohms at 0°C instead of 100 Ohms @ 0°C. The same technique is used for copper **RTD** (10 Ohm), contact **OTEK**. Same connection as Option 47 apply.

Accuracy: $\pm 0.1\%$ of F.S. plus sensor's error. Note: Place NTY as close to sensor as possible.

FIG. 48: 2, 3 or 4 WIRE RTD

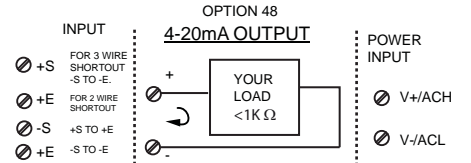

Calibration Direct Reading: $-200-800^\circ\text{C} = 4-20\text{mA out.}$



Note: You can change factory standard calibration via the serial port.

**INPUT SIGNAL CONDITIONERS,
DIGITS 8 & 9:**

Option 50: Thermocouple (Type J): This TC has a range of -210 to +760°C (-350 + 1390°F). Its color is white (+) and Red (-), cold junction (CJ) is at the connector. Make sure the connections from the NT and your TC are as close to the NTs connector as possible to avoid errors. If you short out the NTs inputs +TC & -TC together, the NT will read the ambient temperature at the junction due to its built-in C.J.C.

Note: You can change °C to F and TC type via serial port. Default is °C.

Accuracy & Linearity: ± 1° F.S. of signal input.

FIG. 50: TYPE J THERMOCOUPLE

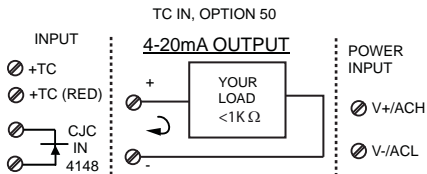

Calibration Direct Reading: -210-760°C-210 to 760=4.0-20.0mA out.

Option 51: TC (Type K): This is yellow (+) and red (-) and has a range of -270 + 1370°C (-440 + 2500°F). The same notes as Option 50 apply.

Accuracy & Linearity: ± 1° F.S. of signal input.

FIG. 51: TYPE K THERMOCOUPLE

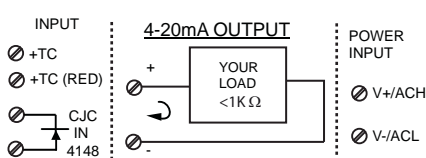

Calibration Direct Reading: -270-1370 °C in=-270-1370=4.0-20mA out.

Option 52: TC (Type T): This blue (+) and red (-) TC has the range of -270° + 400°C (-440 + 750°F). Same notes as Option 50 apply.

Accuracy & Linearity: ± 1° F.S. of signal input.

FIG. 51: TYPE J THERMOCOUPLE

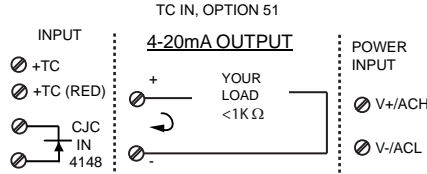

Calibration Direct Reading: -270-1370°C -270 to 1370 in=-270-1370=4.0-20.0mA out.

Option 53: pH (Acidity): We use a FET input (10¹⁵) amplifier and calibrate the NT for 0-14.00 pH using the Industry's standard ± 413 mV = ± 7pH co-efficient.

Note: Not temperature compensated. Contact OTEK for auto temperature compensation.

Accuracy & Linearity: ±0.05% of F.S.

FIG. 53: pH

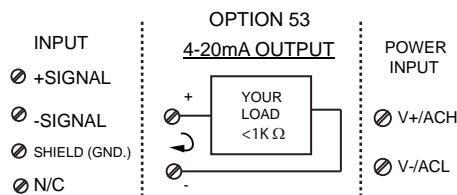

Calibration: +413mV: =0.00; -413mV: =14.00=4.0-20.0mA.

Option 54: ORP (Oxygen Reduction Potential): Our FET amplifier (10⁹) accepts the industry standard 2000mV F.S. of the probe and the NT displays it in % (0-100.0%).

Accuracy & Linearity: ±0.05% of F.S.

FIG. 54: ORP

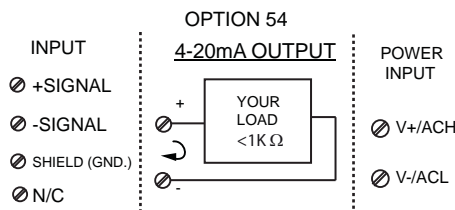

Calibration: 0-2000mV=0-100%=4.0-20.0 mA.

Option 55: %RH: This conditioner is designed to interface to a typical (capacitance type) 2-3pF/% of RH made by several manufacturers. Use Option "29" and contact OTEK to specify your sensor's specifications.

Accuracy & Linearity: ± 1% RH of signal input.

FIG. 55: % RH
OPTION 55

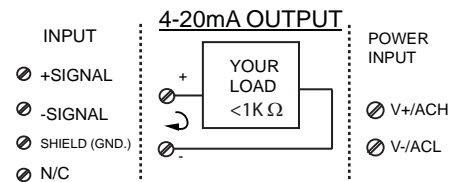

Calibration: Per your supplied data.

Option 56 Resistance (0-10K Ohm): Want a simple 4-20mA transmitter? Just connect a 10K Ohm (others on request) potentiometer to the NT and control any 4-20mA input valve, motor, transducer, etc. Accuracy & Linearity is ±0.1% of F. S. Standard Calibration: 0-10K Ohms=4-20mA. Use option #29 and specify your calibration. An LVDT is a typical application for this option.

Accuracy & Linearity: ± 0.1% of F.S.

FIG. 56: RESISTANCE

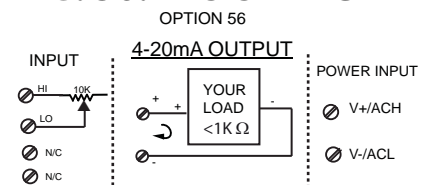

Calibration: 0-10.0 KΩ=0.0-100.0%=4.0-20.0mA.

NTM CONFIGURATOR



Option 57, 10mA-50mA: Convert your old 10-50 to 4-20 and get 100% isolation without changing your transmitter or your wiring. If you use the new dual channel NTI, part number NTI-0XX-270-X01-XX (X=any Option), you can display the input (10-50mA) and the output (4-20mA) simultaneously. See note 8 on page 14.

Calibration: 10-50mA in=4-20mA out.
Accuracy & Linearity: ± 0.1% of F.S.

Option 58: Serial Input Remote Display/Controller: Here you can use the unit as a remote display/transmitter for DCS SCADA, PLC/PAC systems. Just use USB or RS485 to command the NT and to control your load via its 4-20mA output.

FIGURE 58, ISOLATED SERIAL I/O

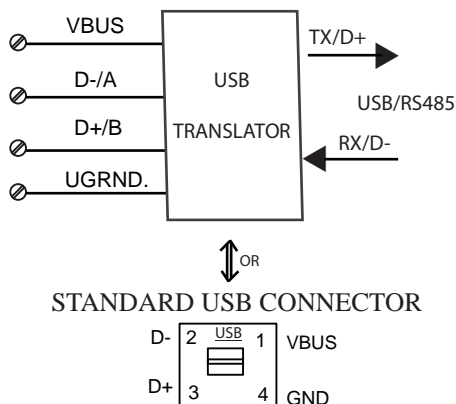

MODEL NTI ONLY:
Mixed input Signal (2 Channels)
Options 60-70:

For multichannel mixed signals. Same specifications as per options 20 through 58.

SCAN HERE FOR
 OTEK'S HOME PAGE



POWER INPUT, DIGIT 10:

Option 0: A.C. Signal Powered: The NT uses the power of the signal to drive its display (~60mW), and convert it to ~30VDC (non-isolated) to power its 4-20mA transmitter. It also converts it to 5VDC to drive its Hi and Lo isolated open collector transistors or its 1A SPDT relays.

Minimum power required by your signal is 1/2W (for the 4-20mA transmitter), and 1/2 W for each relay. You must use **C.T. & P.T.** to isolated inputs to outputs. Your C.T. must be >100:5 ratio. Otherwise, use external power (Digit 10, options 1-4) and input functions (Digits 8 & 9, options 20-58).

Option 1: USB Powered: You can use the VBUS (5VDC) of the USB port to power the NT since the maximum current required by the NT with relays and DAC is under 300mA.

Option 2, 5VDC: 5VDC is used to drive the relays (<100mA total) and/or the DAC via internal isolated 5-30 VDC-DC (<200mA). If you order relays and analog out, you will need ~300mA @ 5VDC.

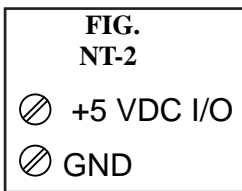

Option 3, 7-32VDC: Same as option 2 but with wide input range of 7-32VDC<3W. (Efficiency: 80%)

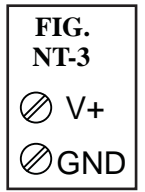

Option 4, 90-265VAC: This option accepts 90-265, 50-60Hz @ <3W. For other inputs, use digit 10, option 9 and specify. (Efficiency: ~80%)



DIGIT 11, MODEL NTT: NO "ON-OFF" CONTROL OUTPUTS AVAILABLE ON MODEL NTT. CONTACT OTEK FOR CUSTOMS.

CONTROL OUTPUTS, DIGIT 11:

Option 1: Isolated Open Collector Transistors (O.C.T.): They are NOT isolated from each other (common emitter) but isolated from all else, and can sink or source a maximum of 30 mA and sustain a maximum of 30V_{CE}. When you order option 2 (Relays), we use the O.C.T. to drive the relays. See option 2 below.

FIG. NT-11

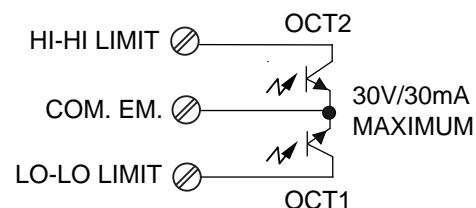

NEED BARGRAPHS/METERS?
 See our NTM
 (New Technology Meter)



NTM-9

Option 2: Relays: are S.P.D.T. (1c) and can switch maximum resistive loads of 1 Amp @ 120 VAC or 30 VDC. They include 300V varistors at their contacts. Factory default: O.C.T. 1/K1: High/Red<10%; O.C.T. 2/K2: Low>90% F. S. For other configurations, use option 9 on digit 14 (field configurable.). Max power consumption per relay: 50mA@5VDC.

FIG. NT-12

OPTION 2 (RELAYS)

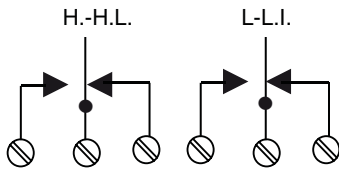

External Control: You can control the O.C.T./Relays via the serial port at will with simple commands. They don't have to be assigned to the bar colors/set points. However, by default, we assign OCT2=K2=Low Limit (red) and OCT1=K1=High Limit (red).

NTS TRANSMITTER



Digit 13 (Scale Plate):

Option 0 is a standard scale plate that reads 0-100%. Use option 9 for custom printing and contact Otek.

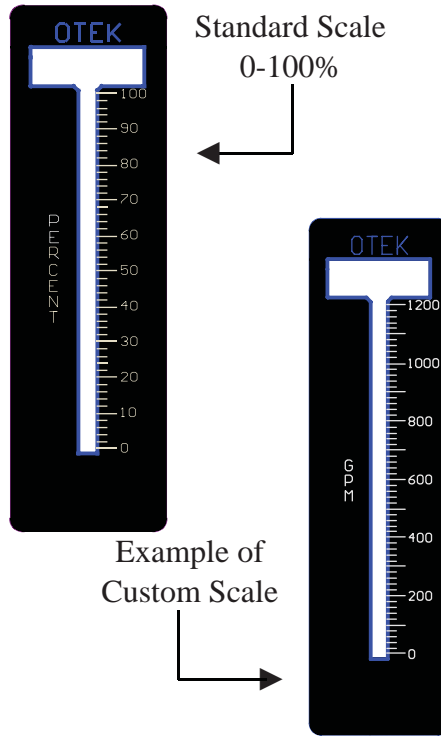

Digit 14 (Range/Calibration):

0=Factory Default: 0-Full Scale Input=0-100% bar and 0-100.0 digits. Colors: <10>90%: Red; <20>80%: Yellow; >20<80%: Green. Use Option 9 (custom) and contact Otek. Also see Control Outputs (Digit 11).

Bargraph Default: 0-full scale=0-100%. You can program it for single pointer, or three or five bars or center zero via the serial port.

UPM-0



UPM-R



UPM-3



NEED COUNTERS/
TIMERS/DPMs?
See our UPM
(Universal Panel Meter)

UPM-H



Notes: Grades E, M & 9 might require an N.R.E. fee.

1. If digit 10 is option 1, then digit 5 must be option 0. USB I/O is powered by VBUS (3mA). RS485 requires 5V@~3mA.

See additional notes below.

***Coming
Soon**

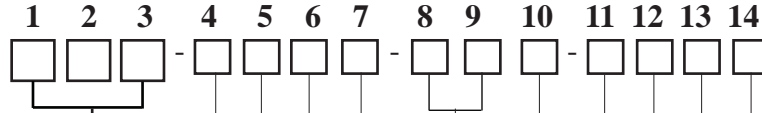

**HOUSING (BEZEL
DIMENSION & MATERIAL) (4, 6)**

- NT0 (1/8 DIN Horizontal, M&P).....
- NTB (1/8 DIN Vertical, M&P).....
- *NTC (PC Module, Plastic Only).....
- *NTI (1" DIN-Rail, Plastic Only) (7).....
- NTS (1x6" Slim, Plastic Only).....
- NTT (3x6", M&P).....
- NTX (4x4" Explosion Proof).....
- NTY (1/8 DIN Rail, Plastic Only).....

4-20mA OUT CONTROL & MODE (3, 8)

- 0.....(Any Model).....Retransmission (Input Signal Driven)
- 1.....(NTS & NTT Only).....Internal Potentiometer Direct
- 2.....(NTS & NTT Only).....Internal Potentiometer Reverse
- 3.....(Any Model).....External 10K Pot. Only (Not Included)
- 4.....(Any Model).....Serial Input Only
- 9.....Custom (Contact OTEK)

SERIAL I/O (1)

- 0.....USB
- 1.....RS485
- 2...Ethernet (Certain Models on Request)
- 9.....Custom (Contact OTEK)

GRADE (5)

- 0.....Industrial & Plastic (Not available for NTX)
- I.....Industrial & Metal (Not available for *NTC, *NTI, NTS,NTY)
- M.....To Mil-Spec & Metal (For NTX/NTY/NTT Only-Contact OTEK)
- E...To EPRI-Nuclear & Metal (For NTX/NTY/NTT Only-Contact OTEK)
- 9.....Custom (Contact OTEK)

OF CHANNELS (7, 8)

- 1.....One
- 2.....(Model NTI Only).....Two
- 9.....Custom (Contact OTEK)

RANGE/CALIBRATION

- 0.....Standard (4-20mA=0.0-100.0)
- 9.....Custom (Contact OTEK)

SCALE PLATE

- 0.....Standard (0-100%)
- 9.....Custom (Contact OTEK)

ANALOG OUTPUT

- 1.....4-20mA Out
- 3...Channel 1 & 2, 4-20mA Out (NTI Only)
- 9.....Custom

CONTROL OUTPUTS (4)

- 0.....None (All Models)
- 1.....O.C.T. (-0,-B,-S,-X & -Y Only)
- 2.....Relays(-0,-B,-S,-X & -Y Only)
- 9.....Custom (Contact OTEK)

POWER INPUT (1, 2, 6)

- 0.....Powerless™ (No Power) {Not available on *NTC}
- 1.....Non-Isolated USB
- 2.....Isolated 5VDC
- 3.....Isolated 7-32VDC
- 4.....Isolated 90-265VAC
- 9.....Custom (Contact OTEK)

INPUT SIGNAL (2, 3, 6, 8)

See Page 14 and enter option number for Digits 8 & 9.

O.C.T. & RELAYS VS. MODEL			
MODEL	4 O.C.T.	2 RELAYS	4 RELAYS
-0	X		X
-B	X		X
-C	X	X	X
-I	X	X	X
-S	X	X	
-T	X	X	X
-X	X	X	
-Y	X	X	

Notes:

2. If digit 10 is option 0, digits 8 & 9 must be options 00-04 & 17. Range for A.C. Signal Powered: 90-140 VAC or 1-4 AAC or 100-560 Watts; must use C.T. & P.T.
3. If digit 4 is option 1-4, digits 8 & 9 must be options 56 or 58.
4. See Table and Digit 11 specifications on page 11. For models *NTC, *NTI and NTT, use option 0 on Digit 11 (No O.C.T. or relays available).
5. Otek will build to certain nuclear or MIL-standards but testing and confirmation of compliance, if required, will need to be done by a third party and at customer's expense.
6. No AC Powerless (Digits 8 & 9, Options 01-04) on *NTC model until further notice.
7. Only model NTI offers 1 or 2 channels. See Digit 7 above and note #8 on page 14.



INPUT SIGNAL

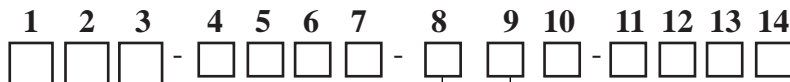

A.C. SIGNAL POWER ONLY (2, 3, 6, 8)

- 01.....Range: 90-140.....Volts A.C., All Channels
- 02.....Range: 2-5.....5 Amps A.C., All Channels
- 03.....Range: 100-600.....Watts A.C., All Channels
- 04.....Range: 40-100Hz/90-140V.....Hertz A.C.V., All Channels
- 16.....7-140 Volts A.C./D.C., All Channels, Signal Power

LOOP POWER ONLY

- 17.....10-50mA, All Channels=Input, Loop Power

INPUT SIGNAL (EXT. POWER ONLY)

- 20.....Input Impedance: 25Ω.....4-20mA
- 21.....1MΩ.....100mVDC F.S.
- 22.....1MΩ.....1VDC F.S.
- 23.....1MΩ.....10VDC F.S.
- 24.....1MΩ.....100VDC F.S.
- 25.....50Ω.....10mADC F.S.
- 26.....10Ω.....100mADC F.S.
- 27.....1M/1MΩ.....Watts DC (1Vx1A) F.S.
- 28.....1MΩ.....Watts DC (1Vx1V) F.S.
- 29.....Custom (Contact OTEK)
- 30.....1MΩ.....0.1V RMS F.S.
- 31.....1MΩ.....1V RMS F.S.
- 32.....1MΩ.....10V RMS F.S.
- 33.....1MΩ.....150V RMS F.S.
- 34.....1MΩ.....250V RMS F.S.
- 35.....5MΩ.....0.1ARMS F.S.
- 36.....0.5Ω.....1ARMS F.S.
- 37.....0.4Ω.....5ARMS F.S.
- 38.....1M/1MΩ.....WRMS (1Vx1VAC) F.S.
- 40.....1M/0.04Ω.....WRMS (120Vx5AAC) F.S.
- 41.....1M.....Hertz (10KHz/5V Logic) F.S.
- 42.....1M.....Hertz (120VAC/40-100 Hz) F.S.
- 43.....1M.....Hertz (240VAC/30-100Hz)
- 44.....1M.....Hertz (120VAC/500 Hz) F.S.
- 45.....Strain-Gage (≥300<4K Ohm)
- 47.....RTD (PT100)
- 48.....RTD (PT1000)
- 50.....TC (Type J)
- 51.....TC (Type K)
- 52.....TC (Type T)
- 53.....pH (0-14.00)
- 54.....ORP (0-2000mVDC)
- 55.....% RH (Specify Sensor)
- 56.....Resistance (0-10KΩ)
- 57.....10-50mA F.S.
- 58.....None (Serial Input Remote Transmitter)

MODEL NTI ONLY:

MIXED INPUT SIGNALS (2 CHANNELS (8))

- 60.....1V Ch.1, 1A Ch.2 (.2 Ω) DC
- 61.....10V Ch.1, 1A, Ch.2 (.2 Ω) DC
- 62.....100V Ch.1, 1A Ch.2 (.2 Ω) DC
- 63.....100V Ch.1, 5A Ch.2 (0.02 Ω) DC
- 64.....150V Ch.1, 5A Ch.2 (.04 Ω) RMS
- 65.....250V Ch.1, 5A Ch.2 (.04Ω) RMS
- 66.....150V Ch.1, 100Hz Ch.2 (120VLine) RMS
- 67.....250V Ch.1, 100Hz Ch.2 (240VLine) RMS
- 68.....None, Serial Input Only
- 69.....Custom (Contact OTEK)
- 70.....Master/Slave Transmitter (See note 8)

Note 8: For Dual Channel NTI:

To monitor both input & output, selection option 70 (Custom) and in description specify Ch. 1 input (Digits 8 & 9, options 01-58 only) and option 00 (loop powered) for Ch. 2 input. Example: NTI-000-270-701-00 (Channel 1=option 57, Channel 2=option 00). Channel 1 will display option 57 (10-50mA) input and transmit 4-20mA out its output. Channel 2 will be loop powered by Channel 1 (4-20mA output) and display the value of Channel 1's output. Example: Channel 1 displays 30.0mA & Channel 2 displays 12.0mA.

Flexibility: Since Channel 2 is Powerless™ & isolated, you can connect its input to a second 4-20mA signal or monitor Channel 1's 4-20mA output. Contact Otek for details & help.



1/8 DIN HORIZONTAL PANEL MOUNT FOR NT0

Note: For the latest information go to <http://www.otekcorp.com/configurator/nts/> and enter your part number, such as NTM-000-122-421-00 (generic part number).

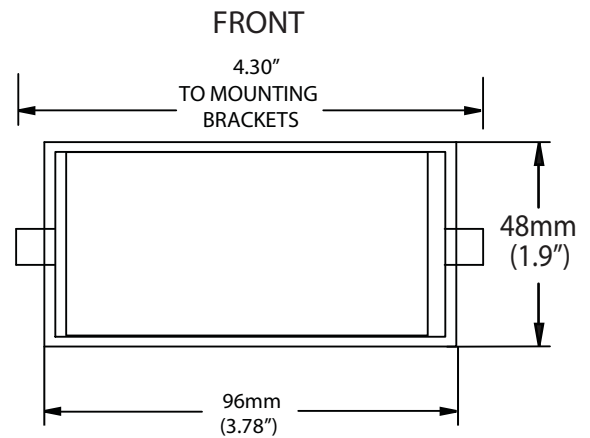
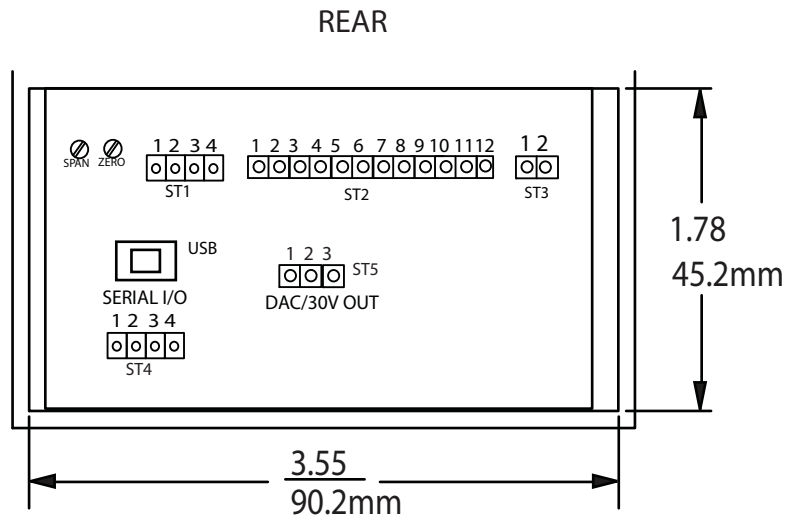
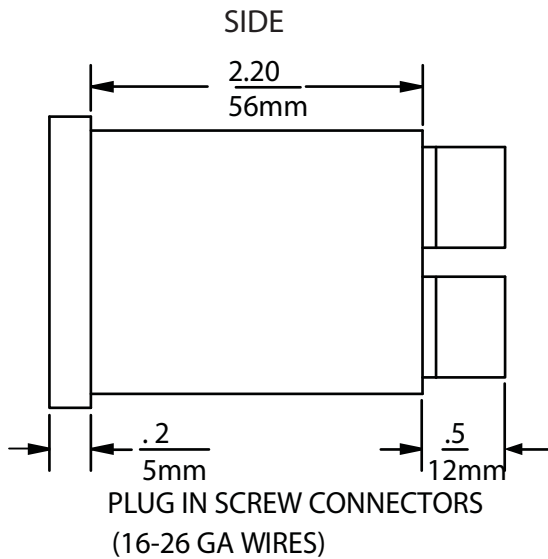

- Panel Cutout: 3.62"W x 1.85" H (92 x 46mm)
- Bezel: 3.78"W x 1.9" H (96 x 48mm)
- Wire: 26-16 GA.
- Connectors might vary with model.



NOTES:

1. The same case is used for both models, the NTY rail mount (Option 0) has connectors on front and clip on rear. The NT0 & NTB panel mount have connectors on rear and display on front and include mounting clamps.
2. Connectors are plug-in style, accept wire 16-26 gauge and extend the depth dimension to 2.8."



1/8 DIN VERTICAL PANEL MOUNT

Note: For the latest information go to <http://www.otekcorp.com/configurator/nts/> and enter your part number, such as NTM-B00-122-421-00 (generic part number).

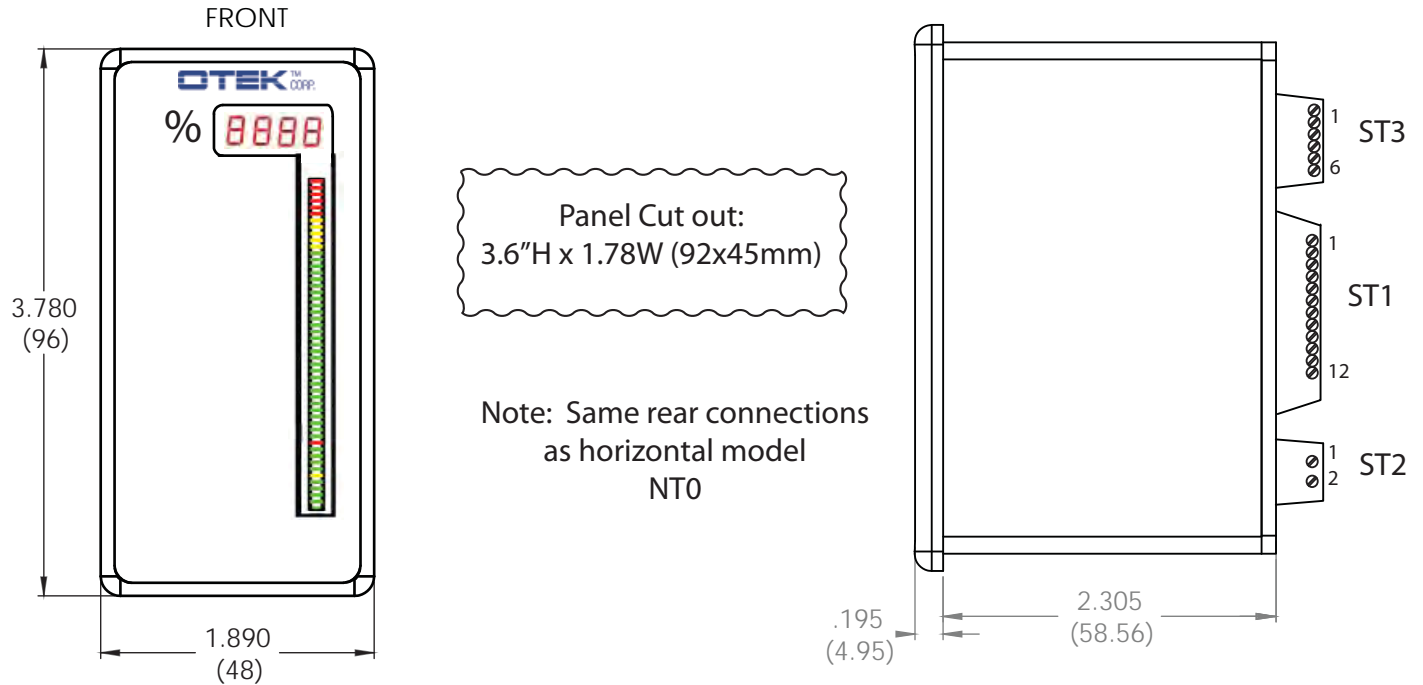

NTC MECHANICAL INFORMATION

UNDER CONSTRUCTION



NTI MECHANICAL INFORMATION

UNDER CONSTRUCTION



NTS MECHANICAL INFORMATION

Note: For the latest information go to <http://www.otekcorp.com/configurator/nts/> and enter your part number, such as NTM-S00-122-421-00 (generic part number).

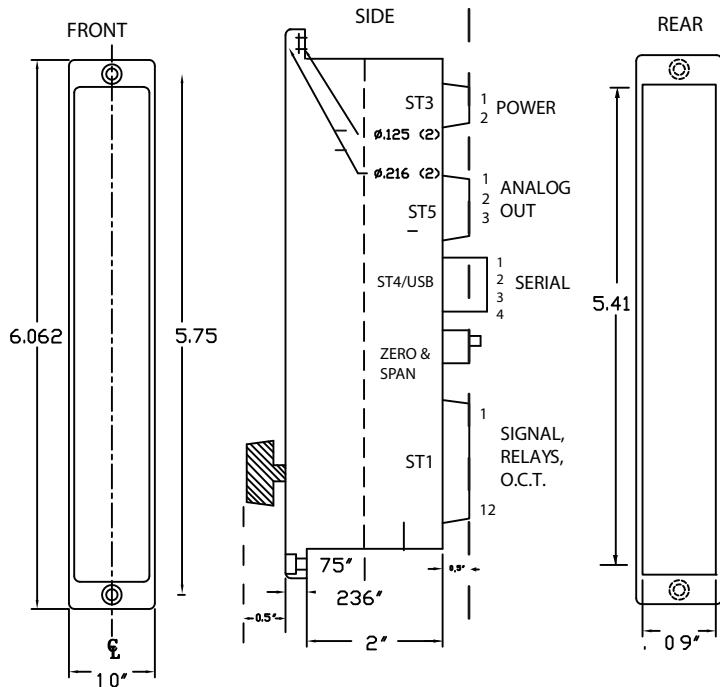

NOTES:

1. Mounting holes (2) at 5.75" centers for #4 (0.125" ϕ) clearance, hardware supplied.
2. Wire size accepted: >24<16 GA.
3. All dimensions: ± 0.010 ".
4. For stacked applications, make mounting holes on 1" centers.
5. Short case (0.75" deep + connectors): Only for VDC power (digit 10, options 2 or 3) and no control outputs (digit 11, option 0).
6. Deep case (2" + connectors): All models with power input and control outputs (digit 11, options 1 or 2).

NTT MECHANICAL INFORMATION

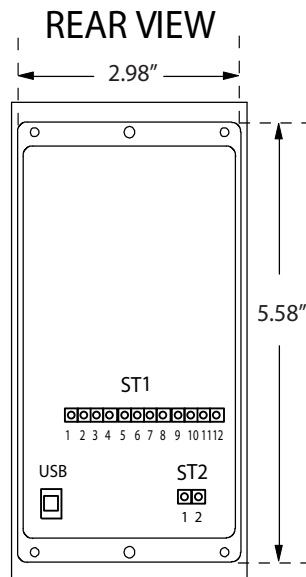
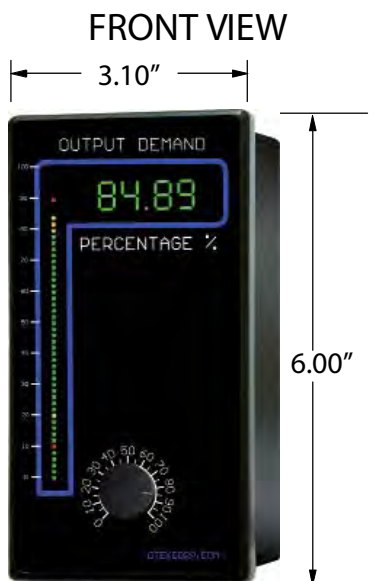

SIDE VIEW

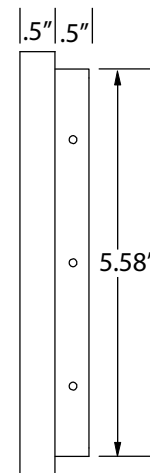

MOUNTING:

1. PANEL CUTOUT: 3.00 W x 5.60" H
2. REMOVE FILTER
3. TWIST MOUNTING TABS
4. REPLACE FILTER



Note: For the latest information go to <http://www.otekcorp.com/configurator/nts/> and enter your part number, such as NTM-X00-122-421-00 (generic part number).

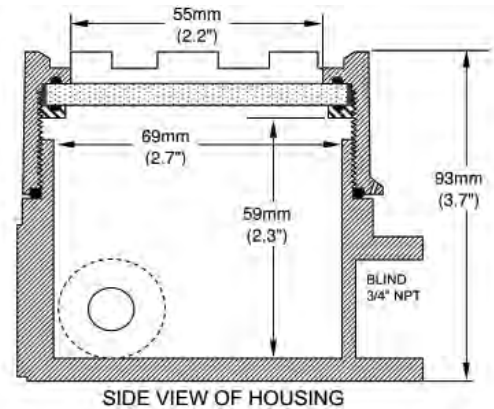
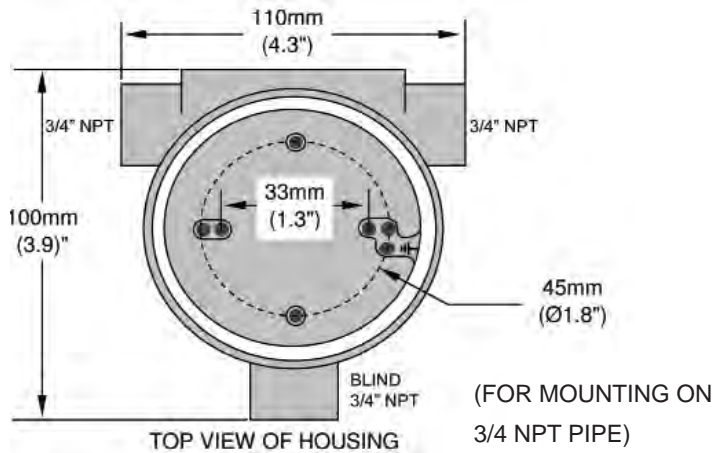

Contact Otek for wall-mount bracket if blind 3/4 NPT can't be used.

NTY MECHANICAL INFORMATION

DINRAIL MOUNTING

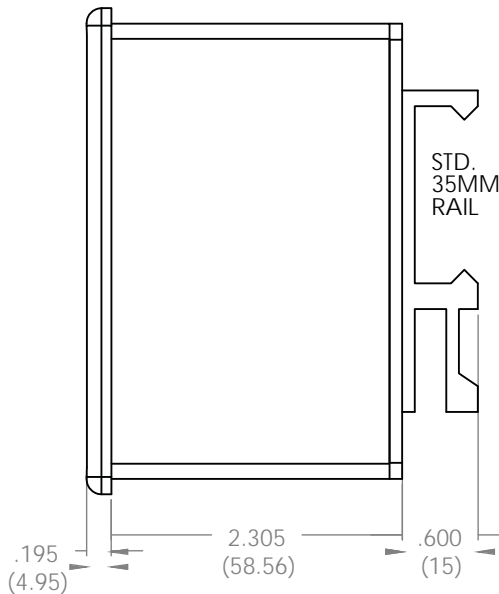
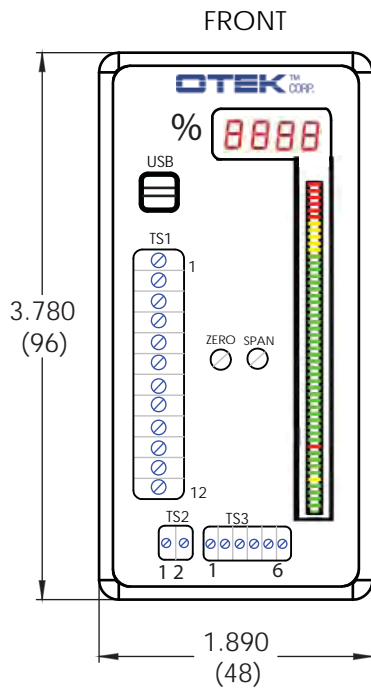

4-20mA
PORTABLE
CALIBRATOR

LOW COST PORTABLE 4-20mA CALIBRATOR/RECEIVER

Model
420

FEATURES:

- Range: 3-21mA I/O
- High Grade Potentiometer For Precise & Smooth Setting
- Built-In Loop Powered Display
- Simple Operation (9V battery)
- High Burden Capability $\leq 1K \Omega$
- Lifetime Warranty (Ltd.)



APPLICATIONS:

- Calibration/Test Of:
- Digital Panel Meters, PLC
- Transmitters, Sensors, etc.
- Current Loop Test/Calibration

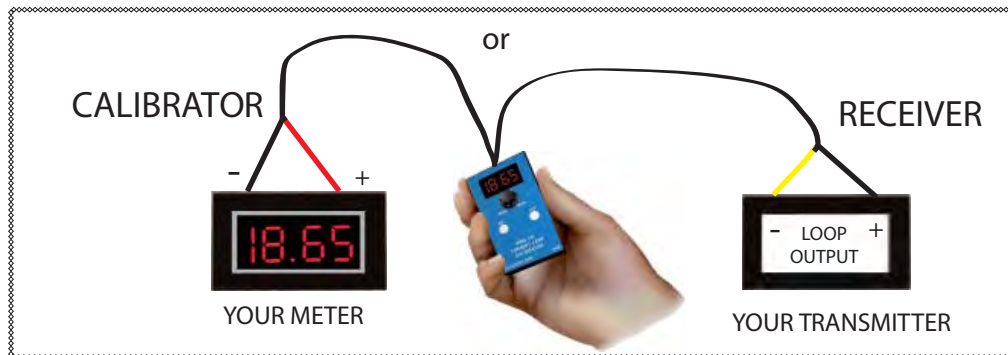

DESCRIPTION: OTEK's New Model 420 was developed by popular demand for a **LOW COST**, no frills field calibrator for any device requiring the popular 4-20mA current loop signal. The 420 comes in a compact 4 1/2 X 2 1/2 X 3/4" housing. **"NO HANDS"** are required to operate the 420 once you press the "ON" button and set the output current desired and when you finish, just press the "OFF" button. Standard range displayed on the 4 digit Digital Panel Meter is 25.00 mA max. Any standard 9V "Transistor Type" battery will power the 420 capable of operating down to 8V. The 420 can drive up to 1K Ω loads or sustain up to 20V burden of the load. Ideal for Loop Powered Instruments! Stand by current (if you forget to turn it off) is a mere 6 μ A!

The Display: OTEK's LPL Series is loop powered and will only turn on if your loop is connected with a load (as a transmitter) and if your loop is **on** (as a receiver). No power to waste!

Transmitter: Just connect your load to the red (+) and black (-) leads, turn on your 420 and adjust the output current.

Receiver: Connect your incoming loop to the orange (+) lead and to the black (-) lead and read your loop value. No need to turn the power on! It's all Powerless™!

Need a PAC (Programmable Automation Controller) transmitter/receiver for your DCS/SCADA or stand alone? See our NT Series.

SPECIFICATIONS (Transmitter):

- *Accuracy of Setting: ± 0.01 mA
- *Stability: ± 0.01 mA (0-60°C)
- *Power Input: 8-12VDC (9V Battery)
- *Minimum Load: 0 Ω
- *Maximum Load: 1K Ω
- *Max. Loop Burden: 20VDC @ 20mA
- *Display Height: 4 1/4" Red LED
- *Output Min/Max: 3/21mA
- *Open Loop Voltage/mA: 25/36
- *Operating Temperature: 0-60°C
- *Storage Temperature: -10 to +70°C
- *Cable: 24" with Alligator Clips & 3.5mm mono male plug (2)

SPECIFICATIONS (Receiver):

- *Loop Powered 3-30mA Range, Calibrated for 4-20mA=4.00-20.00

7-22-16

ORDER: MODEL 420E-\$325.00 FOR LED

-19-

520-748-7900

FAX: 520-790-2808

E-MAIL:sales@otekcorp.com

http://www.otekcorp.com

OTEK™
CORP.

SINCE 1974

Catalog of 1/10/17

4016 E. TENNESSEE ST.
TUCSON, AZ. 85714 U.S.A.

MADE
IN
USA





Build Your Own Part
Number/Receive an
InstantQuote at:
[http://www.otekcorp.com/
configurator/nts/](http://www.otekcorp.com/configurator/nts/)



ABOUT THE NEW TECHNOLOGY METER (NTM) SERIES:



In 1974 Otek introduced the 1st loop powered LCD DPM. In 1985, the 1st LED loop powered DPM. In 1998, the 1st auto tricolor bargraph LCD loop powered bar-meter. In 2005, the 1st LED loop powered bar-meter. Now we bring you the culmination of 40 years dedicated to the POWER of the LOOP!

We are proud to introduce our new NTM Series of instruments! All models use the same patented technology along with our patented hardware and firmware to give you the highest reliability (lifetime warranty) at the lowest cost.

The NTM Series includes various features such as: automatic (programmable) tricolor bargraph, automatic signal fail detect (open or short), indication and serial transmission with run time stamp and unit's ID, isolated retransmission (4-20mA), and universal power input (5-32VDC and 90-265VAC). The NTM Series offers several math functions such as X-Y tables, polynomials and log-anti-log functions.

The UPM Series features the same award winning software and hardware (patented) as the NTM. This allows you to implement many applications, restricted only by the hardware limitation of each model and your imagination.

The new Otek NT product line offers a series of 4-20 mA transmitters suitable for most control applications. The NT Series is designed to replace the old thumbwheel-style controllers with a new device which combines transmitter and controller functions in a single, compact unit. Like the NTM series, NT transmitter/controllers offer: 4 digit, low-power, hi-intensity LED's, 4 digits per display, over 30 input signal conditioners standard, tricolor bar graph with programmable set points, and options for signal or external power. Control functions include: serial I/O, isolated analog retransmission, OCT or relay control outputs.

INSTANT PRICING: Our state-of-the-art **Configurator** allows you to build your specific part number, receive a price and create a customized user's manual. If you already have a complete part number, you can simply enter it to get instant pricing or create the custom user's manual. There is no waiting, no hassle and no RFQ.

**Hard to believe?
Watch our 1
minute video:**



**NEW CLASS 1E!
NOW 10CFR50 APP. B & 10CFR21**

- *Buy Direct From OTEK
- *Eliminate Reseller & Save ~50%
- *Talk Directly to our Engineers and Sales
- *Get our Lifetime Warranty!

ABOUT OTEK:

OTEK Corporation was founded in 1974 by Dr. Otto Fest, whose enduring goal has been to provide the very best in process measurement and control instrumentation, coupled with unparalleled service. Otek designs, develops and manufactures their products right here in the U.S., deploying state-of-the-art technology and using only the highest quality materials and components. Key products include digital panel meters, bargraphs, controllers, batch counters, and process data loggers. The high quality of our products allows us to offer an unprecedented lifetime warranty.

OTEK also offers a 15 day evaluation program at no charge.

