

**AUTO TRICOLOR CONTROLLER FOR MIL-SPEC,  
NUCLEAR AND INDUSTRIAL APPLICATIONS  
> 20 INPUT SIGNAL CONDITIONERS**

**MODEL**

**EBD**

**WOW, LESS THAN 2.5" DEPTH!!! GREAT FOR MINIMAL REAR PANEL SPACE.**

**FEATURES:**

- Powered or Powerless™
- 51 Automatic Tricolor Bars
- 4 Digits (9.9.9.9 or -1.9.9.9)
- Up/Down or Center Zero
- RS232/485/USB Serial I/O
- Industry's Std. 1.77 X 5.7" Cutout
- Use As Indicator/Controller/Remote Display
- Optional 4 each O.C.T. or SPDT Relays
- Optional Analog Out (4-20, 0-5VDC)
- 5, 10-32VDC or 90-265VAC Power
- Front Panel, 2.5" Deep
- Lifetime Warranty
- Power For Transmitter

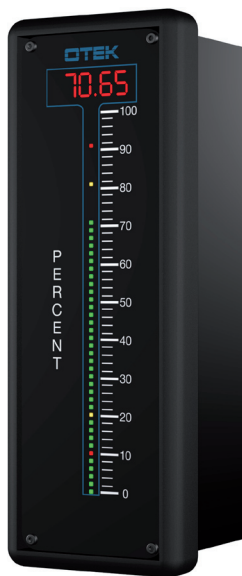

**SPECIFICATIONS @ 25°C 5VDC Power  
(Industrial Grade)**

- Accuracy & Linearity:  $\pm 0.05\%$  of F.S.  $\pm 1$  Digit
- Bargraph Resolution: 2% (51 Segments)
- Span & Zero Range:  $\pm 3000$  Counts
- C.M.V. - Signal to - Power: 2VDC Max.
- Digits: 0.4", 4 (9.9.9.9) Floating Decimal Point
- Temperature Coefficient: 50 PPM
- Operating/Storage Temp: 0-60/-20 + 80°C
- Power Consumption: 750 mWatts @ 5VDC + Options
- Environmental: 5-95% RH N.C.
- Case: All Metal Machined or 94VO Plastic
- **CMTBF:** 100,000+ Hours
- Relays: 1 Amp 120VAC/30VDC (4) SPDT or
- O.C.T.: 30V/30mA
- Analog Out: 16 Bit  $\pm 0.01\%$  (0-1, 4-20mA & 1-5V)
- Serial I/O 300-19.2KB (8N1 Setting)
- Ethernet 10 Base T Compatible

**DESCRIPTION**

The New **EBD** was designed to complement **OTEK's** newest line of **LCD & LED** bargraphs where the highest reliability, latest technology and full programmability are required.

Use the **EBD** as stand alone or part of a **DCS, SCADA**, or **PLC** system via its Serial and/or Analog Output. Only order what you need!

**GRADES:** 3 grades are available: **Hi-Rel** Industrial (see specs.), **Mil-Spec** to specific standards, **Nuclear** to 10CFR50-B and to your requirements. Contact **OTEK** for availability.

**SIGNAL CONDITIONERS:** 20+ input signal conditioners are available (more soon). See ordering information and description sections.

**ZERO AND SPAN:** Either trim pots or via serial port.

**MATH FUNCTIONS:** RTD, TC & X-Y linearization plus Tare, Offset, Scale, Peak and more are programmable via simple commands.

**CONTROL OUTPUTS:** 4 each relays or 4 open collector transistors for High, High-High, Low and Low-Low Control.

**ANALOG OUTPUT:** Optional isolated 4-20mA, 0-1mA, 0-20mA or 0-5VDC with 16 Bit resolution.

**DISPLAY:** The 51 segment automatic tricolor bargraph can be programmed for any direction (up or down), any start (bottom, top, middle), segmented or pointer color change as limits are reached or fixed.

**SERIAL I/O**" Standard is RS232 with optional RS485 or **USB**. You can even power the **EBD** via the **USB** port (2W Max.).

**POWER INPUT:** Standard is 5VDC with optional isolated 5-32VDC or 90-265VAC.

**POWER OUTPUT FOR 4-20mA**

**TRANSMITTER:** Non-Isolated (Options A&B) or isolated (Options 4, 7 or 8)

**PROGRAMMING:** OTEK will configure the EBD at no charge prior to shipment or you can reconfigure it via the serial port using simple commands (See User's Manual at [www.otekcorp.com](http://www.otekcorp.com))

**Warranty: Lifetime Ltd.**

**IF YOU DON'T SEE IT  
ASK FOR IT!**



**EBD Series continued**

**HOW IT WORKS:**

**VDC Signal Powered:** We monitor the voltage with high impedance and clamp it to a safe level to power the **EBD**. (Digit 2, Option 2).  
**Current required:** ~50mA.

**AC Signal Powered:** For VAC & Hz we use a capacitor limiting rectifier to power the **EBD** and monitor the VAC with an RMS-DC converter. For Hz we use an F-V for accurate conversion. For A.A.C. we invented (Pat. #7,626,378) a C-V converter to extract the current from your C.T. for power and monitor the signal with RMS-DC. For Watts, we use a multiplier for actual power.

**Externally Powered:** Non-Isolated 5VDC or isolated 5-32VDC or 90-265VAC 50/60Hz is optional (Digit 3, Options 1-8). Max Power: 750mW plus options.

**Display (Digit 4):** 51 auto-tricolor (RGY) bargraph for trend/Alarm and 4 digits for accurate readings to .01%.

**Serial I/O:** When ordered, (Digit 5), the **CPU** controls the Baud Rate (1200-19200 Baud), the relays, analog output, math functions, linearization polynomial (9th) & X-Y tables.

**Control & Power Out (Digit 6):** You can order 4-20mA as standard, or 0-5V, 0-20mA, or you can order the isolated 30VDC (Options 4, 7, & 8).

**Relays/O.C.T. (Only for powered models):** Either four (4) relays (SPDT) rated contacts at 1A@120 VAC/30 VDC resistive with ~500mS response; with built-in varistors or 4 open collector transistors rated at 30VDC/20mADC common emitter, with <500mS response.

**THE SIGNAL CONDITIONERS:  
(2nd Digit)**

**Option 1: 4-30VDC**

**Signal Powered:**

Another **O TEK** innovation. The voltage signal powers an **LDO** to protect the **EBD** and a divider network is used to measure and display the signal. If the input resistance of this Option is too low (~ 500 Ohms), use powered models. Power Input must be Option 4 (Powerless).

**Accuracy:** ±0.1% of F.S.

**Current required:** ~50mA.

**CONNECTIONS:**

**FIG. EBD-1, 4-30V IN**

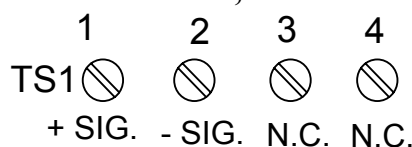

**Option 2: 4-20mA Externally Powered:**

It only drops 1.0V @ 20mA (50 Ohms) but the "**EBD**" needs 5VDC @ 150mA to operate. Power Input must be Options 0-3.

**Accuracy:** ±0.05% of F.S.

**CONNECTIONS:**

**FIG. EBD-2 (2-B, G, H, L-N)**

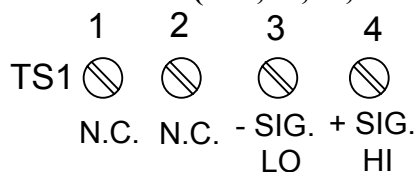

**Options 3-6: VDC & mADC Externally Powered:**

Input impedance is 1 Mega Ohms on all VDC ranges; 100 Ohm on 2mA and 1 Ohm on 200 mADC ranges.

**Accuracy:** ±0.05% of F.S.

For other ranges use Option #9 and specify.

**CONNECTIONS:**

**FIG. EBD-2 (2-B, G, H, L-N)**

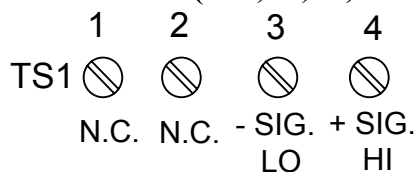

**Options 7, 8 & A:**

**V & mA RMs:** Here we use a **True RMS-DC** Converter for accurate (± 0.05%) measurement of sine waves up to 10KHz (± 0.1% for 10-20KHz) and SCRs fired to ± 1%. Input impedances vs. range are the same as for VDC & mADC ranges. **Warning: No Isolation!**

**Accuracy:** ±0.05% of F.S.

**CONNECTIONS:**

**FIG. EBD-2 (2-B, G, H, L-N)**

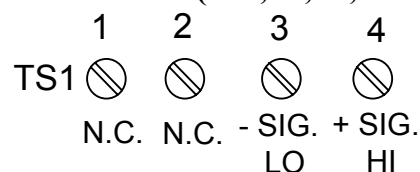

**Option 9: Custom:** Use this option to describe any custom input, scale or modification to the **EBD** and contact us for feasibility and cost.

**Option B: 5 Amps AC:**

Specifically for current transformers (**C.T.**) this option requires an externally mounted (supplied) 0.05 Ohm, 0.1% 5 Watt resistor. You can mount the "Shunt" at your **C.T.** or next to the **EBD** but make sure the connections are "Perfect" to electrical codes.

The **C.T.** might have "**Lethal**" **High Voltage** without a "Shunt" (Open) and the **EBD** will "Smoke". See **O TEK's** New **ACS & CTT** models for **C.T.** powered instruments (Pat. # 7,626,378) or use option "R."

**Warning: No Isolation!**

**Accuracy:** ±0.05% of F.S.

**CONNECTIONS:**

**FIG. EBD-2 (2-B, G, H, L-N)**

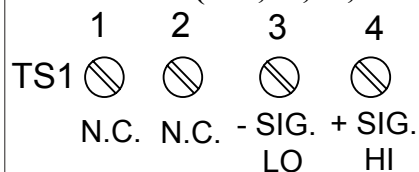

**EBD Series continued**

**Option C: Strain-Gage (<1000 Ohm Type):** Here we use high accuracy and stability constant current (~1mA) source, and a differential amplifier to convert the 2 or 3mV/V (typical) sensitivity of your "Loadcell". *Specify* your Strain-Gage sensitivity and full scale and the **EBD's** display at Zero and Full Scale Please!

Accuracy: ±0.05% of F.S.

**CONNECTIONS:**

**FIG. EBD-C/D (S-G)**

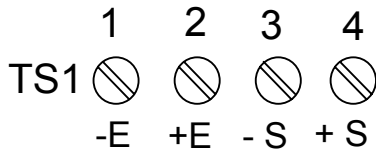

**Option D: Strain-Gage (≥1K < 5K Ohm):** These are typically "Monolithic" **S-G** that require constant voltage (preferably) excitation. We use 4.096V for high stability and accuracy. *Specify* your S-G impedance and sensitivity and the **EBD's** display at Zero and Full Scale.

Accuracy: ±0.1% of F.S.

Note on S-G: Some S-G offer +/- 1VDC or 4-20mA condition output. Use Option 9 and specify.

**CONNECTIONS:**

**FIG. EBD-C/D (S-G)**

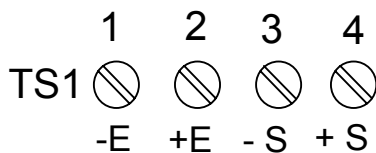

**Option E: RTD (PT100):** We excite your 2, 3 or 4 wire RTD with 200µA to avoid the "self heating" effect. The range of the **EBD** is the same as your **RTD** typically -200°C to +800°C (-328 + 1562°F). You can place the decimal point at will (typically -200.0 to 800.0 (-328.0 to 1562.0)). The **PT100** has a temperature coefficient of 0.00385 Ohms/Ohm/°C.

Accuracy: ±0.5% of F/C plus sensor's error.

Note: For 2 wire, jump -S to -E and +S to +E. For 3 wire only jump -S to -E.

A simple command selects RTD type (PT100 or ANSI 392) and either °C or °F.

**CONNECTIONS:**

**FIG. EBD-E/F (RTD)**

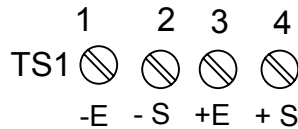

FOR 3 WIRE, JUMP 3 & 4  
FOR 2 WIRE, JUMP 3 & 4  
AND 1 & 2

**Option F: RTD (PT1000):** Same as PT100 except it is 1000 Ohms at 0°C instead of 100 Ohms @ 0°C. The same technique is used. For copper **RTD** (10 Ohm), contact **OTEK**. Same connection as Option E apply.

Accuracy: ±0.05% of F/C plus sensor's error.

Note: For long distances use a 4-20mA transmitter such as our 900 or LPT series.

**CONNECTIONS:**

**FIG. EBD-E/F (RTD)**

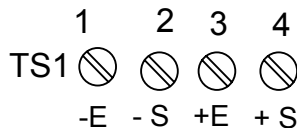

FOR 3 WIRE, JUMP 3 & 4  
FOR 2 WIRE, JUMP 3 & 4  
AND 1 & 2

**Options G&H: Frequency Input:**

We use an **F-V** to accept frequencies from 40 - 20KHz and amplitudes from 1-400V peak or dry contact or open collector transistor (O.C.T.). For 50 or 440Hz power line frequency measurement. Use Option #H or S.

Accuracy: ±0.05% of F.S.

**CONNECTIONS:**

**FIG. EBD-2 (2-B, G, H, L-N)**

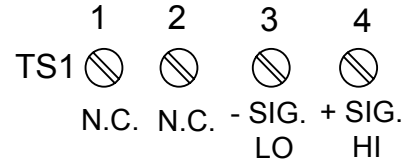

**Option J: Thermocouple (Type**

**J):** This **TC** has a range of -210 to +1200°C (-346 to 2192°F). Its color is white (+) and Red (-), cold junction (CJ) is at the connector. Make sure the connections from the **EBD** and your **TC** are as close to the **EBD's** terminals as possible to avoid errors.

NOTE: You can change from °C to °F and TC type via simple commands on serial port.

If you short out the **EBD's** +**TC** & -**TC** together, the **EBD** will read the ambient temperature due to its built-in C.J.C. (Cold Junction Compensation).

Accuracy: ± 2° F/C of signal input.

**CONNECTIONS:**

**FIG. EBD-J/K (TC)**

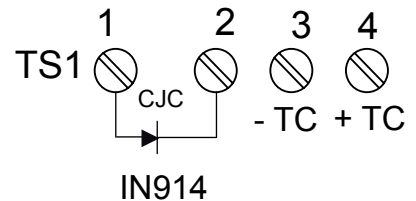

**EBD Series continued**

**Option K: TC (Type K):** This is yellow (+) and red (-) and has a range of -200 to 1372°C (-328 + 2502°F). The same notes as Option G.

**Accuracy:** ± 2° F/C of signal input

**For Other TC use #9 and Specify.**

**CONNECTIONS:**

**FIG. EBD-J/K (TC)**

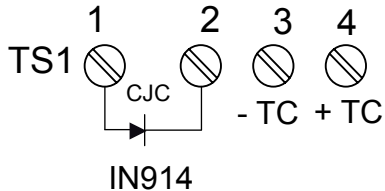

**Option L: %RH:** This conditioner is designed to interface to a typical (capacitance type) 2-3pF/% of RH made by several manufacturers. Use Option 9 and contact OTEK to specify your sensor's specifications.

**Accuracy:** ± 2% RH of signal input.

**CONNECTIONS:**

**FIG. EBD-2 (2-B, G, H, L-N)**

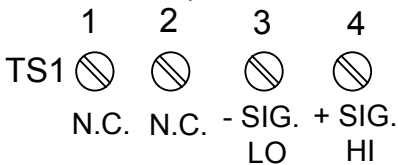

**Option M: pH (Acidity):** We use a FET input (10<sup>15</sup>) amplifier and calibrate the EBD for 0-14.00 pH using the Industry's standard ± 413 mV = ± 7pH coefficient.

Note: Not temperature compensated.

**Accuracy:** ±0.05% of F.S.

Standard display is 0-100% and 0-10,000 counts or use digit 9, option 9 and specify.

**CONNECTIONS:**

**FIG. EBD-2 (2-B, G, H, L-N)**

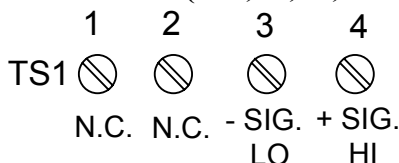

**Option N: ORP (Oxygen Reduction Potential):** Our FET amplifier (10<sup>9</sup>) accepts the industry standard 2000mV F.S. of the probe and the EBD displays it in % (0-100.00%).

**Accuracy:** ±0.05% of F.S.

**CONNECTIONS:**

**FIG. EBD-2 (2-B, G, H, L-N)**

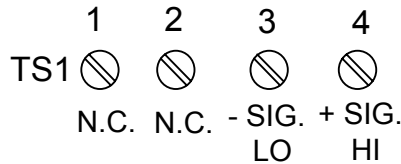

**Option P: Hi Speed Peak & Hold (P&H):** Now you can capture fast transients greater than 5 microseconds

(even faster soon) with resolution greater than 0.1% of F.S. and retention of greater than 10 years (Due to OTEK's new and patent-pending P&H Option).

**Input:** 2VDC/mADC F.S. (Specify Range). Contact OTEK for V/mA RMS or Loop Powered.

**Accuracy:** +/- 0.1% of F.S. +/- 1 Digit. **Linearity & Resolution:** +/- 0.1% of F.S. **Response time:** >200KHz (<5us) **Retention:** >10 years (with power on)

**CONNECTIONS:**

**FIG. EBD-P (P & H)**

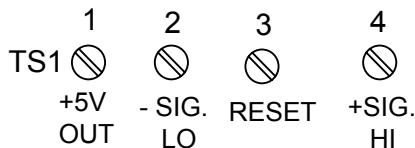

RUN: JUMP 3 & 2  
RESET: PULSE 2 & 3  
PIN 3 HAS 10K PULL UP TO +5V

**Note: Options Q-T only available with Powerless™ Signal power input (Option 4, Digit 3). (Pat. # 4,908,569 & 7,626,378)**

**Option Q: VAC Signal Powered:**

**Warning! No Isolation!** This option uses the AC Voltage Signal to power the EBD. Since the EBD uses about 50mA @ 5VDC, we use a coupling capacitor AC-DC converter to generate 5VDC and not to "Load" the signal with a transformer.

Consequently, your signal source should be capable of producing about 250mW without overloading it, otherwise use Options 7 or 8 (externally powered). Range: 50-150VAC; Method: RMS Calibrated; Accuracy & Linearity: ±0.5% of F.S. Best and safest when driven by a P.T. (Potential Transformer. **Always turn power off before connecting!**)

Note: **No control outputs** (Digit 6) are available.

**CONNECTIONS:**

**FIG. EBD Q-T**

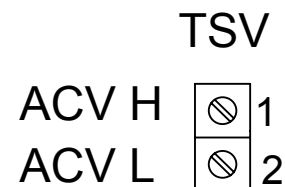



**EBD SERIES continued**

**Option R: AAC Signal Powered:**  
**Warning! No Isolation!** (Pat. # 7,626,378)

O TEK's Patented technique permits the extraction of power from a regular **C.T.** (Current Transformer) to power the **EBD** without distorting the signal. Since this option is designed to be powered from a C.T., it should not be connected directly to the mains without limiting the current and proper electrical grounding. **Lethal Voltage** might be present at the C.T. secondary (output) if the secondary is open.

**Always turn power off before connecting!** Range (at C.T. output): 0.1-5AAC; Overload: 50%/30 seconds; Peak: 100%/1 second; Conversion: True RMS; Accuracy & Linearity: ±0.05% of F.S.; Burden on C.T.: <150mW. Hz: 45-65.

Note: No control outputs (Digit 6) are available.

**CONNECTIONS:**  
**FIG. EBD-R**

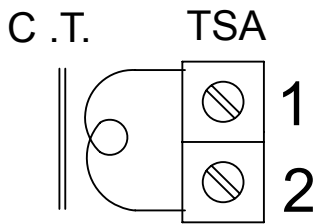

**Option S: Hertz (Frequency) Signal Powered: Warning! No Isolation!** This option uses the same power technique as Option Q above and the same precautions and warnings apply. Here we use a "Zero Crossing" detector and a F-V converter to give you the **A.C.** line frequency display with 0.1 Hz resolution. Range: VAC: 50-150VAC/Frequency: 50-440Hz; Accuracy & Linearity: ±0.05% of F.S. For 400 Hz line, use #9 and specify range.

Note: No control outputs (Digit 6) are available.

**CONNECTIONS:**  
**FIG. EBD Q-T**

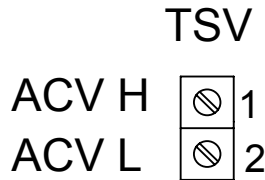

**Option T: Signal Powered AC Watts: Warning! No Isolation!** Here we combine the powerless VAC & AAC options to arrive at real power calculations through our **CPU** and **DAC**. The same warnings and precautions of Options Q & R apply. Range: VAC: 50-150; AAC: 0.1 - 5A; Frequency: 45-65 Hz; Accuracy & Linearity: ±0.1% of F.S.; Conversion: True RMS. Contact OTEK for other functions.

Note: No control outputs (Digit 6) are available.

**CONNECTIONS:**  
**FIG. EBD-T**

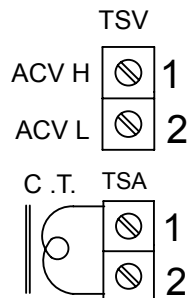

**Power/Input (Digit 3):**

**Option 0: Non-Isolated 5 VDC Power:**

All listed I/O options (except Powerless™) are available. Power requirements vary with options included. The **EBD** with No Control or Power Out (Digit 6, Option 0) requires under 250 mW (50 mA@5VDC). Please add all the options power to the basic **EBD**.

**Options 1, 2, 6 & 7: Isolated Power**

These options offer minimum isolation of 500 VAC or DC and their efficiency is about 80%. Again, add all the options. Selected power x1.2 to arrive at total power required. All input ranges are +/-5%.

**Option 4: Powerless™:** The **EBD** is powered from the signal that it measures. **ONLY** available for options 1 and Q through T of input signal (Digit 2). **WARNING:** Any other I/Os are **NOT** isolated from signal. Options Q-T (Digits 2 & 3) could have lethal potentials!

Note: No control outputs (Digit 6) are available.

**Option 5: Non-Isolated 7-32 VDC:**

We use a switching LDO with a regulated output which accepts 7-32VDC at high efficiency (90%).

**Display (Digit 4)**

Standard configuration is 0-F.S.=0-100% and 0-1,000 counts. Colors are per note #3 on ordering information.

## **EBD SERIES continued**

### **Serial I/O (5th Digit):**

**Option "0":** Parasitic RS232E: Only option 0 on digit 6 is available for signal powered inputs.

**WARNING: No Isolation From Signal.**

**Option 1:** Isolated RS2323: 1200-19.2kb, all ASCII (8N1) open protocol "DB9"

**Option 2:** Isolated RS485: 1200-19.2kb, all ASCII (8N1) open protocol screw terminal connector.

**Option 3:** Isolated USB: 1200-19.2kb, all ASCII (8N1) open protocol "USB Type B."

**Option 4:** Ethernet: Fully compliant 10 baseT and RJ45 connector.

Any terminal program (Hyperterminal, Procomm, Kermit) will work with OTEK's serial com. ports. For USB download our driver at: [www.otekcorp.com](http://www.otekcorp.com)  
Contact OTEK for availability.

### **Control & Power Out (Digit 6):**

**Option 1: Relays (4):** Standard outputs are rated at 1 amp at 120 VAC/30 VDC resistive load. Also applies to option 5 & 7 (Relays). Power required by each relay is 200 mW (40mA@5VDC) x 4=800 mW. (Contact OTEK for 10 A contacts).

### **Option 2: Open Collector Transistors (O.C.T):**

Four O.C.T are included and all are common emitter (sinking) to digital ground. The 5 VDC internal power is available. Maximum current allowed per O.C.T. (From the internal 5 VDC) is 20mA/O.C.T. if external VCC is used, the maximum VCE is 30 VDC and 30 mA per O.C.T. Switching time is under 300ms.

**Option 3: Isolated 4-20 mA (Retransmission):** (Must include serial I/O options 0-4 Digit 5)

This option is offset & scaled via the serial port (digit 5) and can be configured for 4-20, 0-20 or 0-24 mA or 0-5 VDC via internal jumpers (standard is 4-20 mA). This option requires under 200 mA@5VDC internal power. Accuracy & linearity is +/- .1% of setting and can drive up to 1K ohms load. Also see Option B.

### **Option 4: Isolated 30 VDC Output**

You can use it to excite your transmitter at up to 25mA. It consumes under one (1) watt at full load.

**Option 5-8:** Combinations of Option 1-4.

Don't forget to add all power requirements of each option desired. Worst case: 3.0 watts.

**Range/Calibration (9th Digit):** 0-100% and 0-100.0 counts, or use #9 and specify (configurable)

## EBD MECHANICAL INFORMATION

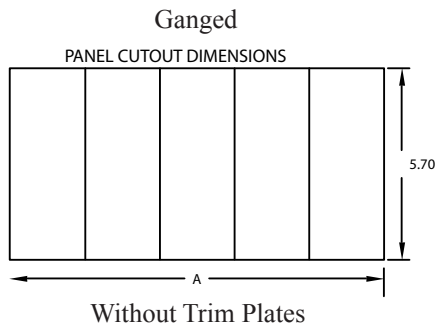
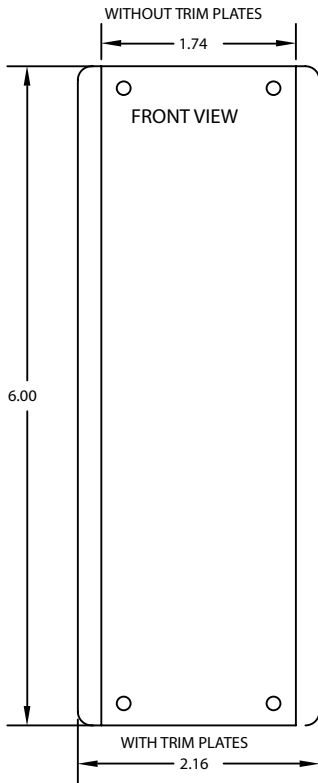

DIMENSION "A"	+0.03 -0.00	+0.76 -0.00
# UNITS	INCHES	mm
1	1.70	44.00
2	3.40	87.00
3	5.10	130.00
4	6.80	173.00
5	8.50	216.00

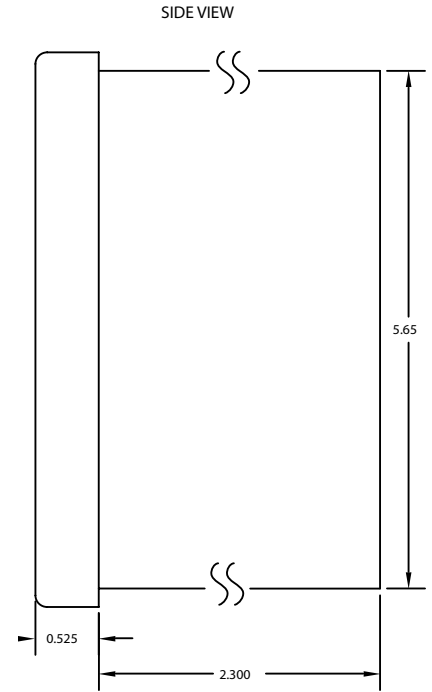

Plastic Trim Plates P/N 50-LBD-2  
Metal Trim Plates P/N 50-119-2

## EBD TYPICAL CONNECTIONS

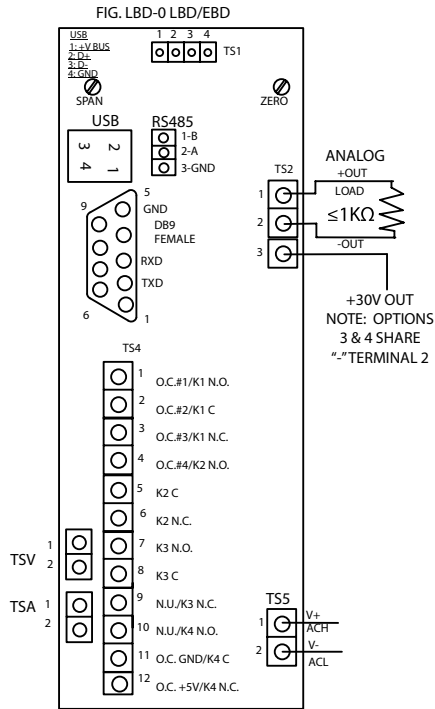

NOTE: INPUT SIGNAL OPTIONS Q-T (A.C. POWERLESS) USE TSA & TSV CONNECTORS. NO TS1, TS4 & TS5 ARE INCLUDED.

SEE DATA SHEET TEXT FOR INPUT SIGNAL CONNECTIONS (TS1)

# EBD SERIES ORDERING INFORMATION 3-20-13

**NOTE: Please READ BEFORE building part number:**

1. If digit 2 is option 1, then digit 3 must be option 4 and digits 5 and 6 must be 0.
2. If digit 2 is option Q-T, then digit 3 must be option 4, digit 5 may be option 1, 2 or 3 and digit 6 must be 0.
3. See notes at bottom of page.

	1	2	3	4	5	6	7	8	9
<b>Model: EBD -</b>	<input type="checkbox"/>	<input type="checkbox"/>	<input type="checkbox"/>	<input type="checkbox"/>	<input type="checkbox"/>	<input type="checkbox"/>	<input type="checkbox"/>	<input type="checkbox"/>	<input type="checkbox"/>
<b>GRADE (4)</b>									
I.....Industrial									
M.....Mil-Spec									
N.....Nuclear (Contact Otek)									
9.....Custom (Contact OTEK)									
<b>INPUT SIGNAL/Z in (1,2,5,8)</b>									
1.....4-30VDC Signal Powered									
2.....4-20mA External Powered									
3.....200mVDC/1M Ohms									
4.....500 VDC/1M Ohms									
5.....2mADC/100 Ohms									
6.....200mADC/1 Ohms									
7.....200mVRMS/1M Ohms									
8.....500VRMS/1M Ohms									
9.....Custom (Contact OTEK)									
A.....2mARMS/100 Ohms									
B.....5ARMS/0.05 Ohms									
C.....Strain Gage<1000 Ohms									
D.....Strain Gage>1000 Ohms									
E.....2, 3 or 4 Wire RTD PT100 (100 Ohms)									
F.....2, 3 or 4 Wire RTD PT1000 (1K Ohms)									
G.....Frequency 40-20 KHz									
H.....Frequency 50-440HZ Line									
J.....TC Type J									
K.....TC Type K									
L.....%RH (Specify Sensor)									
M.....pH (0-14.00)									
N.....ORP (0-2000 mV)									
P.....High Speed Peak & Hold, 2 V									
Q.....VAC Signal Powered (P.T.)									
R.....AAC Signal Powered (5A C.T.)									
S.....50-440 Hertz Signal Powered (P.T.)									
T.....Watts AC Signal Powered (P.T. & C.T.)									
U.....None (Remote Display/Control)									
<b>POWER INPUT (1,2,7)</b>									
0.....Non-Isolated 5VDC									
1.....Isolated 10-32VDC									
2.....Isolated 90-265VAC									
4.....Signal/Loop Powered									
5.....Non-Isolated 7-32VDC									
6.....Isolated 7-32 VDC									
7.....Isolated 5 VDC									
9.....Custom (Contact OTEK)									
<b>RANGE/CALIBRATION (6)</b>									
0.....Standard									
9.....Custom (Contact OTEK)									
<b>SCALE PLATE</b>									
0.....Standard (0-100%)									
9.....Custom (Contact OTEK)									
<b>HOUSING</b>									
0.....Plastic Without Trim Plates									
1.....Plastic With Trim Plates									
2.....Metal Without Trim Plates									
3.....Metal With Trim Plates									
<b>CONTROL OUTPUTS &amp; POWER OUTPUT (1,2)</b>									
0.....None									
1.....Relays (4)									
2.....Open Collector Xtrs. (4)									
3.....Retransmission (4-20mA)									
4.....Isol. 30VDC For Transmitter									
5.....Relays & 4-20mA Out									
6.....O.C.T. & 4-20mA									
7.....Relays & Isol. 30VDC Out									
8.....O.C.T. & Isol. 30VDC Out									
9.....Custom (Contact OTEK)									
<b>SERIAL I/O (1,2)</b>									
0.....Non-Isolated Parasitic RS232E									
1.....Isolated RS232									
2.....Isolated RS485									
3.....Isolated USB									
4.....(Pending).....Ethernet (Contact OTEK)									
9.....Custom (Contact OTEK)									
<b>DISPLAY CONFIGURATION (6)</b>									
0.....Standard									
9.....Custom (Contact OTEK)									

**NOTES (Continued):**

4. Contact **OTEK** for M & N and other grades and supply your specifications. Otek will build to certain nuclear or MIL-standards but testing and confirmation of compliance, if required, will need to be done by a third party and at customer's expense.
5. See description on data sheet. Use option 9 and specify for ranges not listed.
6. Standard configuration is: 0-100% and 0-1,000 counts for F.S. range. Colors are 0-50% = green, 50-75% =orange, 75-100% = red. Field configurable. Specify yours at time of ordering.
7. Maximum power consumption (all options): 10 Watts.
8. Specify sensor manufacturer and type for pH and % RH.

**DOWNLOADS:** For manuals, user-software or drivers:

[www.otekcorp.com](http://www.otekcorp.com)