

NEW

UNIVERSAL DPM/COUNTER-TIMER

3 in 1: TTY/USB/RS485 Display, D.P.M. & COUNTER
Serial Remote Display, Loop/Signal Powered Meter,
Timer/Counter/Clock

UPM-R

PATENT
#9,054,721 B1

Replaces obsolete RM-2300 For
Nuclear & Mil Applications



Typical 8 Digit, 15 Segment Display

SECTIONS:

DPM: P. 2-5

CTR: P. 6-11

REM: P. 11

ORDERING

INFORMATION:

Page 12

CLASS 1E
10CFR50 APP. B
MIL-SPEC &
INDUSTRIAL
GRADES

FEATURES:

- *8 Digits: 9.9.9.9.9 (Counter/Remote Display) or -1.9.9.9 (DPM): 0.4" High, Unicolor Red
- *INPT FAIL Alarm with Run Time Stamp
- *Self Diagnostics
- *Isolated Serial I/O: USB/RS485
- *Only 100mW@5VDC or Powerless™
- *Intensity Control Via Serial Port
- *Math functions (+, -, x, √, ÷, X-Y tables, polynomials)
- *Averaging: None to 255
- *Alpha Characters Selectable
- *Power Input Options: 5, 7-32VDC & 90-265VAC
- *>30 Isolated Input Signals
- *4-20mA/30V Output
- *Lifetime Warranty

DESCRIPTION: The **Universal Panel Meter (UPM)** series combines over 40 years of experience with the latest ASIC uC and ultra-efficient multicolor LED technology to bring you into the 21st century. The **UPM** external power series features over 30 signal conditioners to replace form, fit and function any analog or digital input panel meter. If not, we'll make it!

Our patented hardware and firmware gives you the highest reliability (we have a lifetime warranty) at the lowest cost, with features such as: automatic (programmable) tricolor display (like a traffic light); automatic signal fail detect (open or short); indication and serial transmission with run time stamp and units ID, isolated retransmission (4-20mA), and universal power inputs (5-32VDC or 90-265VAC). The **UPM** Series offers several math functions such as X-Y tables, polynomials and log-anti-log functions.

The **UPM** signal and external power series also feature isolated USB, RS485. You can tell us your custom needs and we'll make it (or might already have it)!

The **UPM-R** is only available in either a loop or an external power version and includes >30 signal conditioners and isolated input power options. Standard factory set color changes are: red: <10, >90%, yellow: <20, >80%, green: >20, <80% of F.S. Use digit 14, option 9 for custom configuration (you can change it with simple commands).

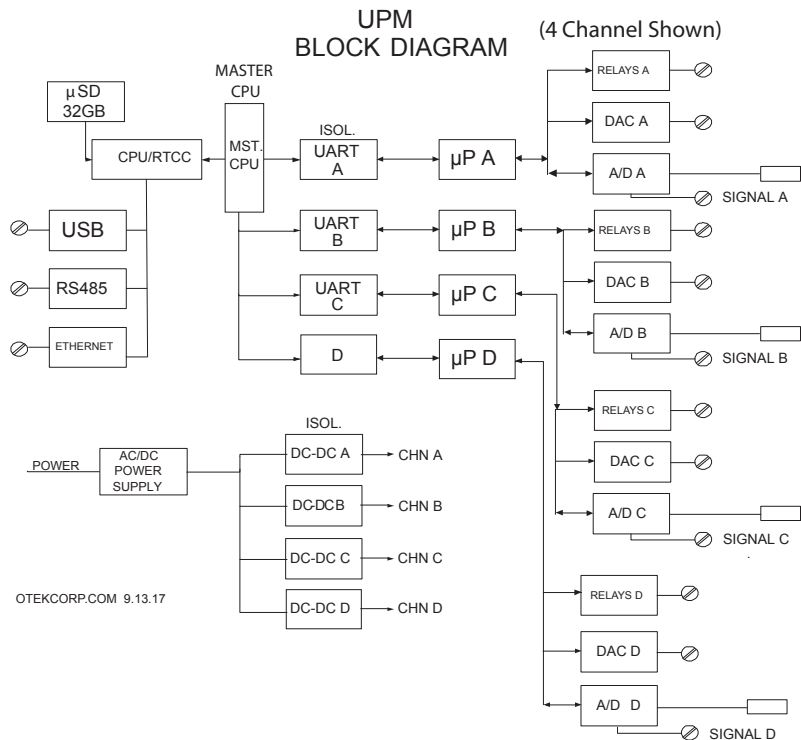

520-748-7900

FAX: 520-790-2808

E-MAIL: sales@otekcorp.com

http://www.otekcorp.com

OTEK™
CORP.
SINCE 1974

2/21/18

4016 E. TENNESSEE ST.
TUCSON, AZ. 85714 U.S.A.

MADE
IN
USA



WHAT CAN YOU DO WITH OTEK'S NEW UPM/DPM FUNCTION?

Description & Notes

All models share the same award winning software and hardware (patent #9,054,721 B1). This allows you to implement the following applications, restricted only by the hardware limitation of each model and your imagination. **Note:** contact us about **Otek's Powerless™ Technology:** If your signal cannot supply $\geq 10\text{mW}$ ($\sim 3\text{V}/3\text{mA}$), use an external power model. See pages 6-11 for **UPM-Counter** functions and Page 11 for remote display/controller.

1. One Channel Only Model: Implement any math function, X-Y table (25 point), polynomials (9th order), offset, zero, scale, tare, log & anti-logarithmic to affect the unit's display at will. Some examples are: change the display & data using any combination as commanded by your algorithm, such as $\pm/\times/\div/\sqrt{\quad}$ or set a variable or linearize the display using X-Y tables or polynomials. This works well for odd shape containers. You can also change the reading from °F to °C or °K or compress/expand the display (and data out) using the log and antilog functions. In addition, you can change the factory default alarm set points and colors or delete them.

Note: Model UPM-F only offers internally accessible USB serial I/O for configuration and mathematical functions. Use digit 14 option 9 and specify your custom calibration, or use our free GUI.

Contact Otek for custom access to micro **USB**.

DIGIT 5, SERIAL I/O & MEMORY:

Settings: 8N1N, 1200-19,200 Baud, ASCII.

Option 0, USB: Complies 100% with V2.0 and if digit **10**, option **1** is selected (USB powered) then digit **5** must be option **0**.

Note on USB Connectors: All models with Digit 5, Option 0 have a standard **type "B"** on the back. **M & E** grades might require "filter" connectors on back and must be specified. Use Digit 5, Option 9 and contact OTEK for **cyber security** compliance to NEI 08-09 & other regulations.

Option 1, RS485: Complies with industry standard. A terminating $< 1\text{K Ohm}$ resistor at first and last unit in the BUS.

Option 6, 20mA C. L. (TTY): Loop powered to accept legacy TTY loop serial data in addition to analog and digital inputs.

Security: Password protected access to the UPM's HW and software. Complies with NEI 08-09 cyber security mandate.
Front Panel Controls: None for added security and safety. Nuclear and MIL-Spec version comply with NEI 08-09 and/or 10CFR50, 10CFR59 and 10CFR 73.54 on request.

DIGIT 6, GRADE:

Industrial Grade (Options 0 or 1) is per these published specifications. Grades **M** and **E** per agreed specifications. Options **E & M** typically include an EMI/RFI shield all around and filtered connectors to meet EPRI-TR-102323-R3 (requiring $\sim 2"$ deeper case). OTEK will build to certain nuclear or MIL-Standards but testing and confirmation of compliance, if required, will be quoted as a separate line item.

Option "**T**" is an aluminium nickel plated case and cover; bezel face has black powder coat finish to Mil-Specs. The back cover is either black plastic or nickel plated aluminum. Typical Mil-Specs: 461, 462, 169, 901, 801, RTCA-160, I EEE344, etc. Contact Otek for custom colors.

DIGIT 7, (# CHANNELS):

This model offers only 1 channel, 8 alphanumeric characters, 0.4" high, unicolor red. Digit 7 must be option 1 or 9.

DIGITS 8 & 9 (INPUT SIGNAL): **SECTION A:**

See Input Signal Conditioners section (pages 4-5) for description and specifications.

DIGIT 10 (POWER INPUT):

LOOP & SIGNAL POWER ONLY:

Digit 10, Option 0, Powerless, No Power Required: The **Input Fail** detect/Alarm (patent pending) flashes the display "INPT FAIL (INPT FAIL)" and transmits this serial message for ~ 20 seconds, after which it will cease. This feature is available in all models. If desired on powered models, use option **9** on Digit **14** and specify "input fail detection." Signal Fail Requirement: Unit must be "On" for at least 1 minutes at $> 50\%$ of full scale for it to operate.



Description & Notes

DIGIT 10 (POWER INPUT): (Continued)

EXTERNAL POWER ONLY:

Digit 10, Options 2, 3, 4; Not available on the **UPM-F**.

Digit 10, Option 5, Non-Isolated 5VDC: 5VDC is used to drive the relays (<50mA/relay) and/or the DAC via internal isolated 5-30VDC-DC (<200mA). If you order relays and analog out, you will need ~300mA/channel. This option is also isolated from the input signal.

Digit 10, Option 6, Non-Isolated 7-32VDC: Same as option 2 but with wide input range of 7-32VDC. Efficiency: >75%.

Digit 11 (Control Outputs): Not available on model **UPM-R**.

Digit 12 (Analog /Power Output): Not available on model **UPM-R**.

DIGIT 13 (SCALE PLATE):

Digit 13, Scale Plate: Option **0** is a standard scale plate that reads 0.0-100.0% or nothing depending on the model number. Use option **9** for custom printing and contact Otek.

DIGIT 14 (RANGE/CALIBRATION):

Option **0**= Factory Default = 0-Full Scale=0.0-100.0 digits. Colors: <10>90%: Red; <20>80%: Yellow; >20<80%: Green. For custom colors, use Option **9** (custom) and contact Otek. Also see Control Outputs (Digit 11). You can program it for other values, none or via the serial port. Default messages: **INPUT FAIL**, **LLAL**, **LALM**, **HHAL** and **HALM**.

OTHER IMPORTANT DATA:

Math Functions: +, -, x, ÷, √, Log/Anti-Log, Polynomials to 9th order, 25 Point X-Y table, zero, offset, span and tare. You can add, subtract, multiply, divide (etc.) one channel to/from another channel and display the result in the other channel (i.e. V (Ch.1) xA(Ch.2)=W(Ch.3). We do it for Watts on options 12, 13, 14, 70-75 and 80-83.

PID: Programmable (best with 2 or more channel models) automatic or manual with external 10K Ohm potentiometer (option **56**). See models our **NT Series** for dedicated 4-20mA transmitters (same technology).

SAME HOUSINGS, DIFFERENT FUNCTIONS



The **NTM (New Technology Meter)**: The same patented technology for analog input only. All else is the same as the **UPM**, but has an automatic tricolor bargraph for trend indication.



The **NTT (New Technology Transmitter)**: Since the **NTM** & **UPM** have 4-20mA outputs, they are transmitters. So, we build them specifically for 4-20mA transmission, change the housing for DIN-Rail or panel mount or explosion proof and you're the winner. No NRE, NO R&D! What's next? **TPM? SSAM?**

ABOUT OUR INPUT FAIL DETECTION

Only available on Powerless™ models (8th & 9th digits, options 00-18). While in normal operation, we store excess energy and use it to power the **UPM** if and when the signal fails (post mortem).



**CLASS 1E
10CFR50 APP. B
MIL-SPEC &
INDUSTRIAL
GRADES**



SECTION A: DPM**Input & Display:** See pages 4-5 for Input Signals:**Note 1:** E and M grade electrical specifications are the same as Industrial unless otherwise specified.**Note 2:** OTEK reserves the right to change specifications without prior notice to improve the performance of its products.

* A/D: Accuracy, Linearity & Resolution: +/- 0.5% of F.S., ±1 LSD. Conversion Rate: 40/sec, Averaging: 0-255, zero, span, offset, tare and math functions.

* Digits: Four Full Active Digits (9.9.9.9 & -1.9.9.9); 0.6" High, Alphanumeric Auto-Tricolor (R/Y/G), 15 segments

* Typical Power Consumption of Display: 10-100mW@3.3V-5V; \loop/signal power version best at > 8mA.

* Temperature Coefficient: +/-50PPM/°C

* Operating Temperature: -10 to +60; Storage: -20 to +70°C

* CCMR: >90dB@50-60Hz

* Isolation: >500VDC to any other I/O & P.S.

* Humidity: 5-95% RH non-condensing

* Front Panel: NEMA 3. NEMA 4X on request.

* Failed Signal Detect: ~ 20 seconds after > 1 minute @50% of F.S. Only on loop & signal powered models.

Note 3: See the master catalog for environmental specs vs. housing.**The Powerful Powerless™**

Yes! You can have the **UPM** (DPM mode only) powered by the input signal and have controlling outputs such as relays, O.C.T. & analog output!

How it works: Your input signal (Digit 8 & 9, options 00-18 only) powers the display, CPU, serial I/O and isolators. Your external power source powers the outputs (if included).

Benefit: You have two independent and isolated sources (fail safe).

Requirement: Your signal must produce >10mW (current loop, VDC, VAC or AAC) and sustain <4V burden. If not, use external power (options 20-85 on Digits 8 & 9).

AC Signal Power & Outputs? Yes, you can have both input options 01-18 (digits 8 & 9) and relays (2 maximum) without external power!

Requirements: VAC input must be >90<140VAC, and AAC input must be >1.5<4 AAC via C.T. Ideal to monitor and control 120VAC mains! Contact OTEK for details.

Important Note on A.C. Powerless

The **NTM**, **UPM** & **NT** Series can extract energy from your A.C. signal to power itself and opto isolated serial, optional O.C.T. (Digit 11, options 1, 3, 5 or 7), and to power the optional 4-20mA output (not 20-4mA out) from a wide input range (see specifications on pages 4-5). External power is required to power the optional relays (Digit 11, options 2, 4, 6 & 8) (200mW each). If you need relays, either use the external powered options on Digits 8 & 9 (33, 37, 40 or 42) and Digit 10 power input options (1-4) or use Powerless™ options 01-04 on Digits 8 & 9 and Power Input option 09 (custom) on Digit 10 and specify (09=Power for relays and DAC). Result: The signal will power the instrument and will include our patented **Signal Fail Detection & Alarm**. The relays and analog output are powered by the external power option (all 100% isolated).

INPUT SIGNALS (Digits 8 & 9):

Note: Otek's exclusive Input Fail detect (open or short) is standard on all inputs. Use option 29 and specify if you want it disabled (also field configurable).

Note: Actual connection will vary. See the User's Manual for specific connection information.

Note: All ±1 LSD and % full scale range unless noted. Also see Note 1 in "Section A: DPM" in previous column.

IMPORTANT NOTE: Options 01 through 18 on Digits 8 & 9 are not available on the UPM-R.

Options 00 For Loop Power Only:

Option 00, Loop Powered: Burden: < 4V; Range: 3-26mA; Accuracy & Linearity: ±0.5% of F.S., ±1 LSD.

Options 20 through 58: For Externally Powered Only:

All input channels have the same specifications unless noted.

Option 20, 4-20mA: Burden: <25 Ohm (0.5V); Range: 3-26mA; Accuracy & Linearity: ±0.5% of F.S.

Options 21 through 24, VDC: Input impedance 1M Ω; Range: Per Option; Accuracy & Linearity: ±0.5% of F.S.



**Options 20 through 58: For Externally Powered Only:
(Continued)**

Options 25 & 26, mADC: Input impedance Option **25:** 50 Ω ;
Option **26:** 5 Ω ; Accuracy & Linearity: $\pm 0.5\%$ of F.S.

Option 27, Watts DC (1Vx1A DC): VZin: 1M Ω /AZin: 1.0 Ω ,
5W; Range: 1W; Accuracy & Linearity: $\pm 0.5\%$ of F.S.

Option 28, Watts DC (1Vx1V): VZin: 1M for both inputs;
Range: 0-1V; Accuracy & Linearity: $\pm 0.5\%$ of F.S.

NOTE: Always use **P.T.** or **C.T.** with H.V. Lines (Options **30-34**).

Options 30 through 34: VRMS: Zin: 1M Ω ; Range; per op-
tions; Accuracy & Linearity: $\pm 0.5\%$ of F.S.

Options 35-37, Amps RMS: Zin: Option **35:** 2 Ω ; Option **36:**
0.2 Ω ; Option **37:** 0.04 Ω ; Range: Per option; Accuracy & Linear-
ity: $\pm 0.5\%$ of F.S.

Option 38: Watts RMS (1Vx1V AC/DC): Zin: 1M Ω for both
inputs; Range: 1V RMS; Accuracy & Linearity: $\pm 0.5\%$ of F.S.

Option 40, Watts RMS (120VAC P.T. x5AAC C.T.): Zin: 1M for
V & 0.04 Ω for A; Range: 0-750W; Accuracy & Linearity: $\pm 0.5\%$
of F.S. Note: Shunt resistor (0.04 Ω) supplied.

Option 41, Frequency (10KHz/5V Logic): Zin: 1M; Range:
30-10KHz; Accuracy & Linearity: $\pm 0.5\%$ of F.S.

Option 42, Hertz (120V, 40-100Hz): Zin: 1M; Range:
50-150V/40-100Hz; Accuracy & Linearity: $\pm 0.5\%$ of F.S.

Option 43, Hertz (240V, 30-100Hz): Zin 1 M; Range:
100-260V/30-100Hz; Accuracy & Linearity: $\pm 0.5\%$ of F.S.

Option 44, Hertz (120V, 500 Hz): Available on a Powerless
(90-140VAC/370-420 Hz) or external powered unit. For external
power, just use option 44 on Digits 8 & 9 and specify. On the
Powerless model, use option 09 (Custom) on Digit 8 & 9 and
specify Option #44. (requires >1 watt from input signal). For
240 VAC/400 Hz, use option 29 & specify.

Zin: 1 M; Range: 50-150V/300-500Hz; Accuracy & Linearity:
 $\pm 0.5\%$ of F.S.

Note on Strain Gages: Specify impedance, sensitivity, range
and calibration. Example: 350 Ohms, 2mV/V, 10mV=0-100.0%.

Options 20 through 58: For Externally Powered Only:

Option 45, Strain Gage (<1K Ω): Excitation: 4V; Range: 300-1K
 Ω ; Accuracy & Linearity: $\pm 0.5\%$ of F.S.

Option 46, Strain Gage (>1K Ω): Excitation: 4V; Range: 1K-5K
 Ω ; Accuracy & Linearity: $\pm 0.5\%$ of F.S.

Option 47 & 48, RTD: 47: 100 Ω (PT100); **48:** 1K Ω (PT1000);
Range: same as RTD; Excitation: 0.5mA; Accuracy & Linearity:
 $\pm 0.5\%$ of F.S. 2, 3 or 4 wire RTD. For 3 wire, connect -E to -S. For
2 wire, also connect +E to +S. Warning: Max distance to sensor:
 \sim 300 Feet (100 M) or use our **NT** transmitters.

Note for Options 47-52: You can switch from $^{\circ}$ F to $^{\circ}$ C via serial
port or use option 29 and specify. Default: $^{\circ}$ F (uses internal
linearized table).

Option 50, Type "J" TC: Range: -210 to 760 $^{\circ}$ C; Colors: red and
white; CJC: Included; Accuracy & Linearity: $\pm 2^{\circ}$ C of F.S.

Option 51, Type "K" TC: Range: -270 to 1370 $^{\circ}$ C; Colors: Yel-
low and red; CJC: Included; Accuracy & Linearity: $\pm 2^{\circ}$ C of F.S.

Option 52, Type "T" TC: Range: -270 to 400 $^{\circ}$ C; Colors: blue and
red; CJC: Included; Accuracy & Linearity: $\pm 2^{\circ}$ C of F.S.

Note for Thermocouples (TC): Shorting out the +/-TC input
terminals will display the ambient temperature of the C.J.C. at
the input terminals.

Option 53, pH: Range: 0-14.00; Zin: >10¹⁵ Ω ; Temperature
compensation: None; Accuracy & Linearity: $\pm 0.5\%$ of F.S.

Option 54, ORP: Range: 0-2000mV; Zin:>10⁹ Ω ; Accuracy &
Linearity: $\pm 0.5\%$ of F.S.

Option 55, % RH: Range: Per sensor; Input Type: 2-3 pF
Capacitance; Accuracy & Linearity: $\pm 0.5\%$ of F.S. State sensor's
specifications.

Option 57, 10-50mA Range: 10 Ohms input resistance
Accuracy & Linearity: $\pm 0.5\%$ of F.S. ± 1 Digit.

Option 56, Resistance Range: 0-10K Ω =0-100%=0-100.0; Ac-
curacy & Linearity: $\pm 0.5\%$ of F.S.

Option 58, None: Serial input only as per Digit **5** for remote/
display controller.



B) THE UNIVERSAL COUNTER/TIMER CLOCK (Digit 15, Options 1-9 and A-L):

The **UPM** can function as a **universal counter**: It accepts digital inputs to perform over 20 functions, all of which can be selected by serial input commands.

Functions: Batch – Debouncer – Draw – Frequency – Integrations – Julian Clock (RTC) – Log/Anti-Log Extractor – Period – Phase Angle – Positioning – Quadrature – Range – Rate (1/F) – Ratio– Square Root – Stopwatch – Time Interval – Totalizer – Up/Down Counter –Up/Down Timed (Milliseconds to years!).

Features: Fully configurable for any listed function via serial port.
 * Same features as **DPM** section except it is only offered in external power (Digit 10, options 1-4).
 * Same features as **NTM** series except it has an Alpha-Numeric Tricolor Display instead of a bargraph.
 * Multiple isolated displays (up to four) allow for complex math functions/display/control of process variables such as Volts/ Amps/Watts/Frequency/Pressure/Flow/Volume and temperature, and PID or **redundant control**.
 * Three angle positioning (X, Y, Z).
 * Intelligent (HMI) moving messaging (up to 18 characters).
 * Automatic process control (MMI) and much more.

Input and Output Terminals and How To Use Them:
 Note: Not to be confused with input signals for measurement.

Besides the regular input signal terminals, the **UPM** has other external terminals to control its functionality. These functions can be enabled via serial command or managed by the internal function selected. Refer to customized user’s manual.

Terminals that are already dedicated and controlled externally have a 5K pull up to the isolated 5VDC of its channel and only accept 5V logic levels or dry contacts.

Borrow (only in the first stage of a string): Connect “Borrow” pin to “Carry” pin of previous unit (or channel) to expand the number of channels.

Carry (only in the last stage of a string): Connect “Carry” pin from the first unit to the “Borrow” pin of the next unit (or channel) to expand the number of characters.

Count Hold (Digit 15, Options 5, K, L): “Grounding” this pin (5K pull up) forces the counter to stop counting.

Display Hold (Digit 15-, Options F, K): “Grounding” this pin (5K pull up) holds the display, but allows the counter to continue counting.

Input and Output Terminals and How To Use Them: (Cont'd):

Frequency out (Digit 15, Options 5, F, K): This pin is the F out of the signal conditioner after it has been converted to 5V logic levels. Minimum load=1K Ohm. Useful for F-V.

Run/Stop (Digit 15, Option G): This pin is functionally the same as “Counter Hold” except has a <1µS response time.

Frequency Response (No De-Bouncer): Useful for DCS/ SCADA/PAC interface, <1µS response time.

Reset (Digit 15, Option 5): This pin is used to reset the internal accumulated count and has no De-Bouncer since its used in “Frequency” counter (up/down) modes. Response time:<1µS.

Up/Down (Digit 15, Option 3): Leave this pin open for “UP” count or “ground” it for “DOWN” count. If connected to an encoder, connect “UP” into “A” and “DOWN” into “B” and “RESET” to “Z” for rotary zero detect encoders.

Inputs/Functions (Digits 8 & 9 and 15): Conditions: If digits 8 & 9 have options 00 through 58, 60-68, 70-78 or 80-88, then digit **15** must be option “0 (None):”

Up/Down Counter (Option 1): (also see “Quadrature” counter)
 A counter is a totalizer that can be enabled/disabled by several means such as an input (gate), a command (serial), or a result of another action produced by your algorithm, such as CHA + CHB/ CHC = 0. Therefore, start/stop counts or times on CHD, which can be useful to synchronize 3 phase power lines or radiation counters. If you use the F-V option, you can convert analog signals to digital format for higher accuracy synchronizing. Imagine the possibilities limited by your algorithm!

UPM FIG 1: u/DC, Option 1

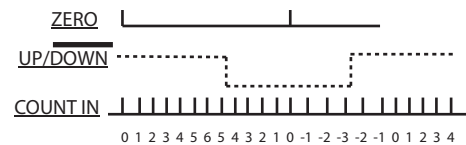

Totalizer (Counter) (Options 2 & 1A-4C): This function accumulates the number of pulses received on Input A after Input B has been taken high (↑), will sum the events for as long as Input B remains high and will decrement on the falling edge (↓) of Input B. You can switch the logic of Inputs A and B via simple commands and by using the command “TOTDN” (totalizer down) instead of “TOTUP” (totalizer up), you can enable any controlling output/message (relay, O.C.T., DAC, color change, message, etc.).

Multiplier: (also see "Divider") In some applications the input data needs to be multiplied to arrive at unity count such as tanker to barrels, barrels to gallons, gallons to liter, etc. Select the appropriate multiplier of your choice with up to four decimals (xxxx.yyyy).

Divider: (also see "Multiplier"): Some applications require counting in multiples of units such as dozens/bag, gallons/barrel, liters/cask, etc. Just select the divider number and count in desired unit of measurement (1/2, 1/56, 1/500, etc.).

Quadrature (Option 3): (also see "Datum Zero") This function includes inputs for Input A (count), Input B (direction), and Input Z (datum zero). When Input A rising edge (↑) leads Input B rising edge, the UPM will increment its count by one (1). When Input B leads Input A, it will decrement its count by one (1). Regardless of Logic state of Inputs A or B, when Input Z transitions from Logic 0 to 1, the UPM will reset to zero. This is important when using rotary encoders to indicate the zero degree point. Again, the resolution of the measurement is determined by the number of pulses/rotation of your encoder and the multiplier you select. But you can display/control the process in decimal or clock (360°:60M:60S) format. Linear encoder is used for length measurements/control, rotational encoders for rotational (degrees) applications. The automatic tricolor change will warn the operator of anomalies.

The UPM can be forced to zero count via a serial command or an OR connection at the Z Input since it has a 10KΩ pull up to 5V (high to reset to zero, low to run). The Z (zero) pulse should be as short as possible (>1μS) to avoid missing a count.

UPM FIG 3: Quad A, Option 3

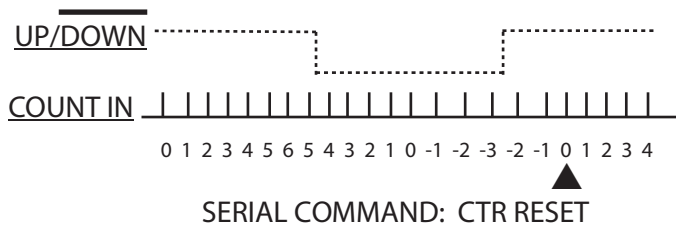

3.1 Zero Datum: (also see "Quadrature" and "Up/Down" Counter) This single pulse/revolution is produced by rotary encoders to indicate 0° and it is used by the UPM to zero its display and start counting up or down in a degree fashion with degrees, minutes, second, and milliseconds of rotation determined by the resolution of your encoder. For linear measurements, use command "LIN." For rotational, use the command "ROT."

3.1 Zero Datum: (Continued)

UPM FIG 3.1: Quad B, Option 3

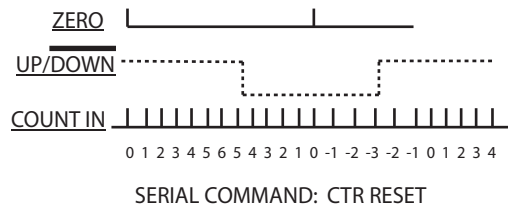

Batch (Option 4): Use "Batch" to count or measure specific amount of product in a container. Example: gallons in a barrel, peanuts in a jar, pills in a bottle, etc.

Batch Total: Use "Batch Total" to add the total number of batches of a specific product. Example: barrels in a tanker, jars in a box, boxes in a skid, skids in a truck, etc.

UPM FIG 4: Batch, Option 4



Frequency (Option 5): Use "Frequency" to totalize the number of pulses over a fixed measure of time. Example: 60 Hz = 60 cycles or pulses/second such as a household electrical line, 94.652 MHz might be the transmitting frequency of a radio broadcaster, etc. Note: "Frequency" is normally defined as events (pulses) per second (10/s, 1k/s/MHz). "Rate" is defined as events (pulses) per minute, hour, day for slow-occurring events versus a unit of time. See Rate (1/F), such as in oil rigs.

UPM FIG 5: Frequency, Option 5



SECTION B: COUNTERS (Continued)

5.1 De-bouncer/Filter: UPM's Debouncer (Filter) function is useful when the input signal is from relay contacts that "bounce" or are of an AC nature. Select a "debouncer" time base that covers the worst case condition of the bouncing signal. Relays typically have a bouncing time of 5–20mS, so a time base >25mS will be safe to use. However, if the switching (on-off) speed of the relay is <30mS, you should not use a time base greater than 25mS. The best time base would be approximately >15 and <20mS. This is also useful for AC power lines (>18mS for 60 Hz, >22mS for 50 Hz, or >3mS for 400 Hz power lines).

UPM FIG 5.1: De-Bounce, Option 5

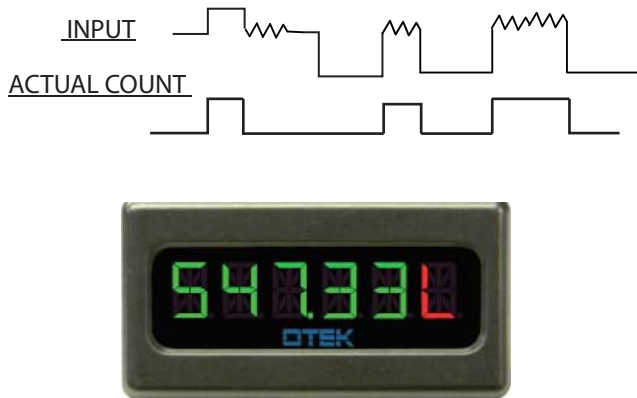

5.2 Burst: There are applications where it is desirable to measure the "burst" of a frequency input and ignore the base frequency. In this case, select a gate time > the minimum (maximum normal) burst frequency. Example: Normal: < 1 kHz, burst > 1.5 kHz < 20 kHz. Select a gate of 1.4 mS. The UPM will only display the burst's frequency of approximately 3.2 kHz. Want to count the number of bursts? Enable the counter function and the UPM will display the number of bursts since last reset.

UPM FIG 5.2: Burst, Option 5

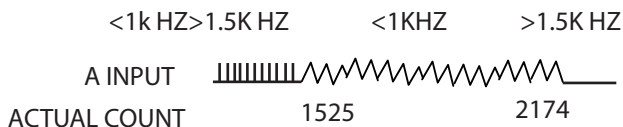

Period (Option 6): Use "Period" to measure/control the duration (width) of a signal transition from Logic 0 to Logic 1 (low -> high). Its measurement resolution is determined by the gate time selected (10 μS to 10 sec.). Again, you can use the math functions to meet your algorithm needs such as CHA + CHB, CHA - CHB, CHC x CHD, CHC/CHB/√, etc.

RADs (Option 7): Also known as units of radiation (radiation absorption dose) or "grey" units in SI. Radiation transmitters/sensors produce either analog output (4-20mA) or pulses. If pulses per "grey," you can accumulate (totalize) the number of pulses over a period of time. If analog, you can integrate logarithmically the total "dose." See integrator.

REMs (Option 8): A.K.A. Si (Sievert). Radiation detectors/transmitters produce either a pulse per unit of radiation (~0.01 Sievert) or analog signal (usually mV or 4-20mA). In either case, the UPM accepts both signals and if pulsed, it totalized the number of pulses received. If analog, it uses the integration function, along with the log or anti-log (contracting or expanding) for the reading and gives you the accurate rate (dose) of accumulated radiation in an area.

Custom (Option 9): Contact OTEK for your custom algorithm/application. Typical custom design that replaces F, F & F obsolete 20mA C.L. (teletype) input 1960's technology with the UPM-R.

(UPM-R)
1.5x5" Case



Up/Down Timer (Option A): Just like the Up/Down Counter (Option 1), but instead of using external pulses to count, the UPM uses its internal programmable time base to increment/subtract its count. Default is one (1) second, range is 1 μs to 10 seconds.

Time : There are three (3) times: **time interval** (Option B), **elapsed time** (Option C) and **range time** (Option D).

SECTION B: COUNTERS (Continued)

Elapsed time means time that has occurred from the starting point and range time means estimated time to end of task (if all conditions remain as they are). Elapsed time requires a time base selection, a "Start" pulse and an "End" pulse, both rising edge (positive Logic). Range time requires a time base selection (mS to seconds), a reference input signal (events/time base), and a "Total" goal or destination value.

Note: You can enable/disable the up/down function via serial command.

Example: Assume you want to know how long it will take to fill a tanker, whose capacity is 164,000 barrels, at a present rate of 3450 barrels/hr. However, if the rate varies to 2945 or 3649/hr, how long will it take in seconds, minutes, hours, or days? The **UPM** will automatically update its display and serial output as well as its analog output (for PID control) to inform you of the calculated end of process. All math functions are available for you to automatically select multipliers, dividers, or external variables as required. Also, you can use the V-F input option to convert analog inputs (4-20 mA, 1-5 V, etc.) to events for the range time algorithm. If you have a mileage "Range" indicator in your car, the **UPM's range** function works the same.

UP/DOWN TIMER

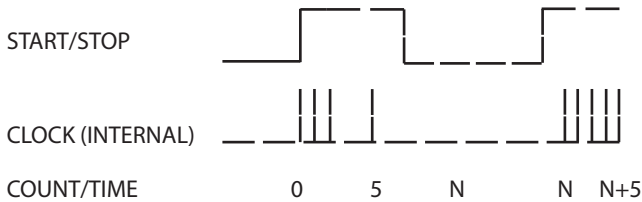

Time Interval (Option B, continued): This measures the time interval between two (2) inputs A and B and starts on the rising edge (↑) of Input A and stops on the rising edge (↑) of Input B. Alternatively, you can select the falling edge (↓) or start with Input B and select your time base (μS to seconds) and any actions to occur (relay, O.C.T, display change, math functions, average, etc.). If you use a "Gate Time" function, you can display/control the average of all the pulse widths that occurred during the gating time.

INTERVAL

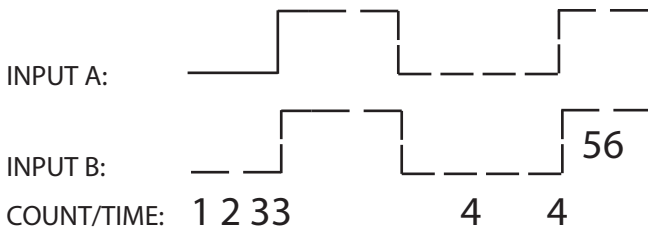

Elapsed Time (Option C): Depending on the model selected (number of characters/digits), you can display/control events in days, hours, minutes, seconds, mS, and μS (D:365, H:24, M:60, S:60, μS:000,000 for a 15 digit model(s) or 5 digits for the smallest package (-L). Use the relays, O.C.T. or analog output to control your process by setting limits/alarms (usually 00:00:00).

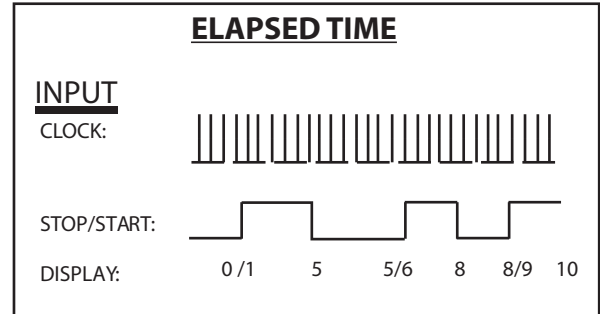

Range (Option D): This function is extremely useful in determining how long (range) the asset you have (fuel, beans, water, etc.,) will last you if you maintain the present usage at the present rate. It's no different than a retiree wishing that his money will outlast him, or wondering if you have enough gas to get to the next gas station or calculating whether the rods in a reactor will last until the next "load" arrives. All you need to do is enter the value of "In Stock," and the **UPM** will use prior (if programmed into the memory) information to determine the range. You can also enter the rate/unit (unit=time, events, etc.) and the **UPM** will calculate the range.

Contact sales@otekcorp.com with information on your transducer. You'll need to provide data such as:

- 1) Existing fuel intake
- 2) Fuel used (if not full)
- 3) Present consumption/time

The **UPM** will calculate the range based on actual use of fuel per unit of time or events.



Julian Clock {RTC} (Option E): Use "Julian Clock (RTC)" to indicate time, date, and year and control any loads via the four relays or analog output (4-20 mA) of any channel. Four and five digit models alternate the display as follows:

2014 (year) **12 (mo.) **27 (date) 10:15 or 20:15 (hrs and min) 45.07 (sec and mS)

or

2014 (year) *159 (day) **27 (date) 10:15 or 20:15 (hrs and min) 45.07 (sec and mS)

or month, date, year, time or time, data, month, year.

Place any callout in any order and use "*" to indicate dead space. Enable/disable any on-off (Relay/O.C.T.) at any specific time/date/year or analog output to any value.

Example 1: K1ON 2015**08 **15 07:15; K1OF 2015**09 **01 *9:30; Turns on Relay K1 on August 15th at 7:15 a.m.; turns Relay K1 off on September 1st at 9:30 a.m. in year 2015.

Example 2:

2015 (year)*AN1 *4.00 (mA) **10 (month) **19 (date) 23:59 (time)

2015 (year)*AN1 *8.50 (mA) **10 (month) **20 (date) 05:30 (time)

2015 (year) *AN112.00 (mA) **10 (month) **20 (date) 09:30 (time)

2015 (year) *AN116.00 (mA) **10 (month) **20 (date) 12:30 (time) 2015 (year)*AN1 20.00 (mA) **10 (month) **21 (date) 2400 (time)

Turns analog out to 4.0 mA on October 19th of 2015 at 23:59 (11:59 p.m.), holds it at 4 mA, then switches its outputs to 8.50 mA on the 20th of October at 5:30 a.m., then to 12.00 mA on October 20th at 9:30 a.m., then to 16.00 mA on the 20th of October at 12:30 p.m., then to 20.00 mA on October 21st of 2015 at 12 midnight (2400 hours).

Date/Time: You can make your own format to suit your country's needs. Just identify the label and sequence in moving message. You can control any and all four Relays and DAC per channel at will. Default format: U.S. standard: month – date – year – hour – minute – second. Note: Models with 12+ characters (-4) are best suited for calendar-controlled functions.

Rate (Option F): (also see "Frequency") Rate is used for slow occurring events such as strokes/minutes, GPM, LPM, barrels/day, etc. instead of fast occurring events which are measure in Hertz (usually seconds) such as radio frequencies or power lines.

F.1 Digital Mode Rate: Rate uses the 1/F formula to arrive at the rate per unit of time by counting the number of events that occur within the time base used. If you want to measure/control the process that produces approximately 1/second, use the 1 or 10 second time base. This will give you a reading of approximately 60 EPM (events/minute) or 3600/hr with fractions of an event (3600.3), if required. This is commonly used in oil rigs to measure the barrels/day produced without using a flow meter.

F.2 Analog Mode Rate: If your process produces an analog signal such as 4-20 mA, 1-5 mA, 1-5 V, 0-10V or other, you can use our option 1C, 2C, 3C or 4C (voltage to frequency) to convert/scale the analog to digital form and follow the example noted in Digit Mode Rate C.1. Rate is used to calculate/display the frequency of slow occurring events in a short period of time (seconds) without having to wait minutes, hours, or days to find their frequencies. All you need to do is select the time base (gate) in 0.1, 1, or 10 seconds and multiplier (60 [M], 3600 [H], 86900 [D]) to determine the unit of time.

Contact us at: sales@otekcorp.com.

Ratio (Option G): Ratio is the ratio of two (2) signals (A/B) to determine their positive (greater) or negative (smaller) frequency vs. each other. Normally, it is used to synchronize their zero crossings such as in power lines (synchrosopes), other matching frequency applications (radio broadcasts), or conveyor speed synchronization. Using the UPM analog output as proportionally controlled by the output of the "Ratio" function can automatically synchronize the objects similar to PID.

Phase Angle (Option H): (needs 2+ inputs) It measures the phase relationship between any two inputs and its value is displayed in degrees (0:00:00 to 360:00:00) formatted DDD:MM:SEC.000 (degrees, minutes, seconds, and milliseconds of rotation). Best with 6 digit models.

Draw (Option J): Use "Draw" to measure/control two variables that should maintain identical amounts, speed, velocity, etc. Draw = A/B – 1 is same as "Ratio," but 1 unit is subtracted from it to give you a zero display (differential) when their ratio is 1:1. Example: Two conveyors should be travelling at the same speed/tension/level and the UPM will display the differential between them.

V-F {Voltage to Frequency Converter} (Option K) : The UPM series offers an optional high accuracy and resolution V-F (also F-V) Converter capable of converting a 0-1 V signal (or 4-20mA and others on request) to 0-100 kHz giving you a 0.00001V (10µV) resolution (+/-0.000001% of full scale). When you use this option, converting pressure to flow and/or volume using the √ function becomes a very economical and accurate alternative to old techniques.



SECTION B: COUNTERS (Continued)

Integrations (Option L): Use "Integration" to integrate, accumulate or totalize events (pulses) over an open period of time (seconds, minutes, hours, days). Also see "Totalizer," "Event Counter," "REM Counter," "Logarithmic," "Anti-Log," and "Volume." Using our V-F (voltage to frequency counter) option, you can convert analog signals to frequency, such as pressure to flow and volume using our "Square Root" extractor function.

Examples: TBW

L.1 Square Root: This standard feature of the **UPM** allows you to convert the differential pressure from a pressure transmitter to instantaneous flow, and if you enable the integrator mode, to accumulate (per unit of time) the flow into volume.

SECTION C: REMOTE DISPLAYS

C) REMOTE DISPLAYS (Digits 8 & 9, option 58)

As a remote (serial input) display/controller, the **UPM** has no analog or digital inputs enabled or tested, but it can have On-Off Control (Digit 11) and/or Analog Outputs (Digit 12). This will allow you to control your process with your own commands/algorithm and simultaneously display an intelligent message to the operator (HMI/MMI). Imagine the possibilities!

SECTION D: CONTROLLERS

D) CONTROLLER:

It can function as a **controller:** It includes an isolated optional analog output (4-20mA) that is internally powered and capable of driving up to 1K Ohm loads. The SPDT relays (4/channel) are capable of driving up to one (1) Amp at 120VAC/30VDC resistive loads. 300V MOVs are included. The open collector transistors (O.C.T.) are isolated from the signal and power inputs and can drive up to 30mA@30VDC/VCE, such as S.S.R.

CUSTOMS

Class 1E (Nuclear Safety), Military (to specific MIL-Specs) and industrial grades are available. We have been supplying our armed forces, and the aerospace and nuclear industries for over 30 years.

SECTION E: OTHER USES

E. OTHER USES:

E.1 It can function as a **scientific meter:** It performs math functions (+, -, x, ÷, √), X-Y tables, polynomials, range, log-antilog with exponential (ideal for RAD/REM a.k.a. Gy/SV).

E.2 It can function as a **smart message center:** We use ultra-efficient 15 segment automatic tricolor (R/Y/G) LEDs for full alphanumeric display. Number of characters vary with model. Serial I/O includes isolated USB, RS485 or Ethernet.



E3. It can function as a **data logger (paperless recorder):** Some models include an optional removable 32GB μSD memory card for data storage and it is configurable to meet your needs via simple commands. Standard factory configuration is when any limit is reached and include the units I.D. number, name, run time stamp, limit data and message.

E.4 **ABOUT ISOLATION:** All models in the OTEK **New Technology** series include 100% isolation (>500VDC) between **ALL** I/O, including serial I/O, power input, control outputs (relays and O.C.T.), analog outputs and signal (analog or digital) inputs. The **UPM-F** is "display only" and has no outputs.

CONCLUSION

CONCLUSION:

As you can see, the **UPM** is truly the **Universal Panel Meter** you have been waiting for. All the listed functions (and more) are included and found in the User's Manual, making the **UPM** a versatile microcomputer with controlling capabilities superior to a **PLC** and inferior to it in cost and size. You can use it to perform most any task. If not, contact us to solve the problem together.

Use Note: Remember the **UPM's** recording capabilities with its exclusive 32 GB memory capacity. That can save you lots of headaches.



UPM-R ORDERING INFORMATION 2/21/18

**SEE NOTES
BELOW**

UPM-R

1 2 3 4 5 6 7 8 9 10 11 12 13 14 15
U P M - R 1 - - 0 0

HOUSING (Bezel Dimension & Material)

R.....1 Ch., 8 Digits (1.5x5")

SERIAL I/O

0.....USB
 1.....RS485
 6.....20mA C.L. (TTY)
 9.....Custom (Contact OTEK)

GRADE & CASE*

1.....Industrial & Metal
 3.....Industrial & Metal NEMA 4X
 M.....To Mil-Spec & Metal (Contact OTEK)
 E.....To Epri-Nuclear & Metal (Contact OTEK)
 9.....Custom (Contact OTEK)

*Grades E, M & 9 might require an N.R.E. fee.

OF CHANNELS

1.....One
 9.....Custom (Contact OTEK)

INPUT SIGNAL: LOOP POWER ONLY (1)

00.....4-20mA, Loop Power

INPUT SIGNAL: EXTERNAL POWER ONLY (2-5)

20.....4-20mA (All Channels Same Input)
 21.....100mV DC F.S.
 22.....1VDC F.S.
 23.....10VDC F.S.
 24.....100VDC F.S.
 25.....10mADC F.S.
 26.....100mADC F.S.
 27.....Watts DC (1Vx1A) F.S.
 28.....Watts DC (1Vx1V) F.S.
 29.....Custom (Contact OTEK)
 30.....0.1V RMS F.S.
 31.....1V RMS F.S.
 32.....10V RMS F.S.
 33.....150V RMS F.S.
 34.....250 V RMS F.S.
 35.....0.1A RMS F.S.
 36.....1A RMS F.S.
 37.....5A RMS F.S.
 38.....W RMS (1Vx1VAC) F.S.
 40.....W RMS (120Vx5A AC) F.S.
 41.....Hertz (10KHz/5V Logic) F.S.
 42.....Hertz (120VAC/40-100 Hz) F.S.
 43.....Hertz (240VAC/30-100 Hz) F.S.
 44.....Hertz (120VAC/500 Hz) F.S.
 45.....Strain-Gage ($\geq 300 < 4K$ Ohm)
 47.....RTD (PT100)
 48.....RTD (PT1000)
 50.....TC (Type J)
 51.....TC (Type K)
 52.....TC (Type T)
 53.....pH (0-14.00)
 54.....ORP (0-2000mVDC)
 55.....% RH (Specify Sensor)
 56.....Resistance (0-10K Ω)
 57.....10-50mA F.S.
 58.....None (Serial or TTY Input Remote Meter)
 1A.....Any Digit 15 TTL Input Level
 1B.....Any Digit 15 H.V. Input Level
 1C.....Any Digit 15 V-F (Option K) Input Level

COUNTER/FUNCTIONS

0.....None (Use Digits 8 & 9)
 1.....Up/Down Counter
 2.....Totalizer
 3.....Quadrature
 4.....Batch
 5.....Frequency
 6.....Period
 7.....RADS
 8.....REM
 9.....Custom
 A.....Up/Down Timer
 B.....Time Interval
 C.....Elapsed Time
 D.....Range
 E.....Julian Clock
 F.....Rate
 G.....Ratio
 H.....Phase Angle
 J.....Draw
 K.....V-F (Voltage to Frequency)
 L.....Integration

RANGE/CALIBRATION

0.....Standard (0-100.0)
 9.....Custom (Contact OTEK)

SCALE PLATE

0.....Standard (No Markings)
 9.....Custom (Contact OTEK)

ANALOG/POWER OUTPUT

0.....None
 9.....Custom (Contact OTEK)

CONTROL OUTPUTS

0.....None
 9.....Custom (Contact OTEK)

POWER INPUT

0.....Powerless™ (No Power)
 1.....Non-Isolated USB
 2.....Isolated 5VDC
 3.....Isolated 7-32VDC
 4.....Isolated 90-265VAC
 9.....Custom (Contact OTEK)

NOTES:

1. # of input channels is governed by Digit 7.
2. Options 20 through 1C only for externally powered models (Digit 10, options 1-9).
3. Options 20 through 1C only for externally powered models (Digit 10, options 1-9).
4. Option 1A accepts 5V TTI/CMOS inputs or dry contacts (10K Ω pull ups). Option 1B accepts dry contacts to 150V DC/AC pulses. See "Debouncer/Filter" definitions. Option 1C accepts 0-1V DC & 4-20mA. See "V-F" definition. Conditions: If digit 15="0," then digits 8 & 9 must be options 00-58 and vice-versa. If digit 15="1" thru "L" then digits 8 & 9 must be 1A-1C and digit 10 (power) must be option 1-9. Option H (Phase angle) requires 2 inputs.
5. Digit 5, Option 6 (Teletype Input) only available with option 58 on Digits 8 & 9. Only for TTY Remote Display.

520-748-7900

FAX: 520-790-2808

E-MAIL: sales@otekcorp.com

http://www.otekcorp.com



SINCE 1974

2/21/18

4016 E. TENNESSEE ST.
TUCSON, AZ. 85714 U.S.A.

MADE
IN
USA



MECHANICAL INFORMATION

(Shown for A.C. power and TTY input. Other inputs will vary.)

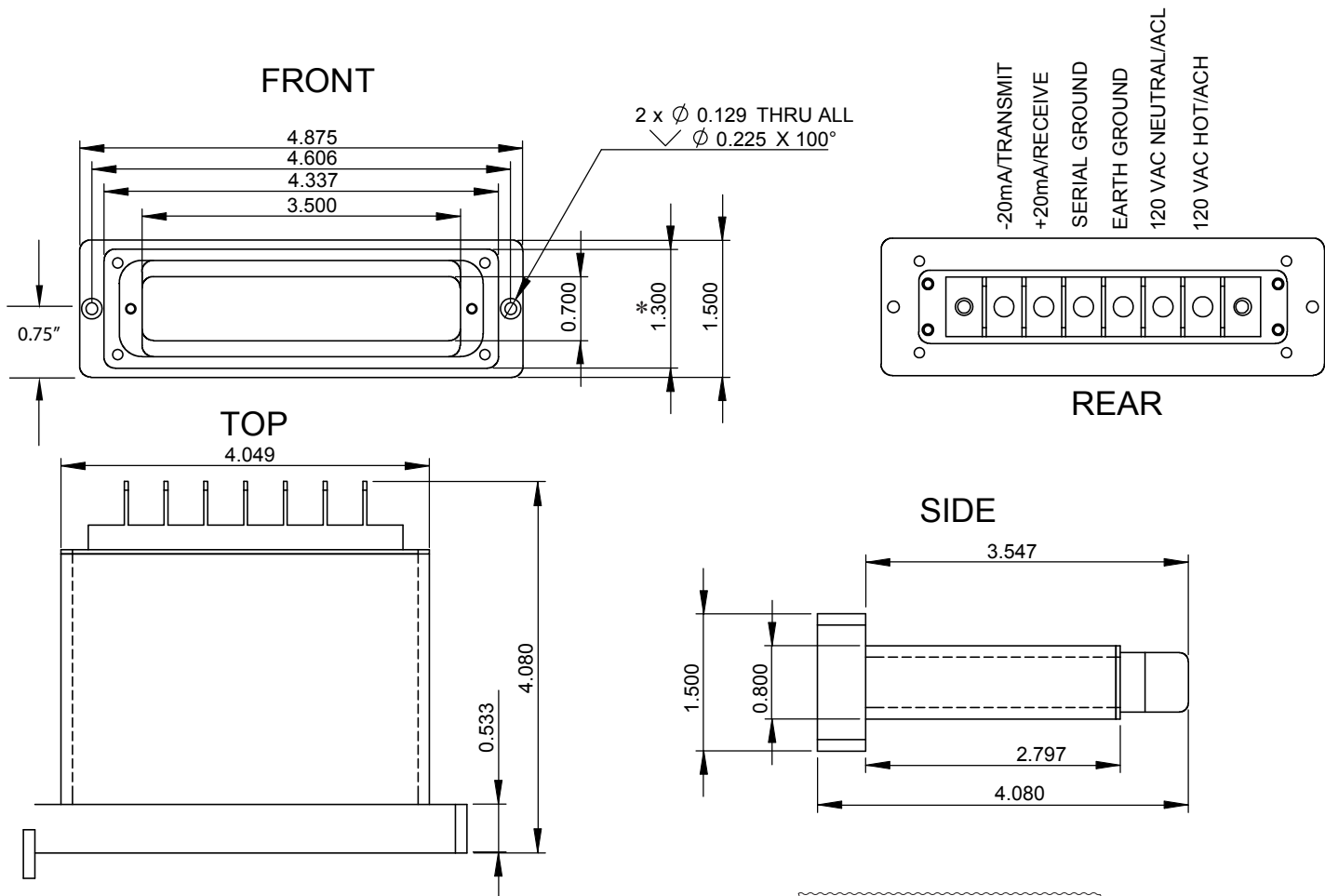

NOTES:

1. Maximum depth not to exceed 4 inches behind panel.
2. Serial ground terminal is provided for grounding shield of signal cable. It is not required if cable is grounded at the other end. Connect earth ground terminal to cabinet ground.
3. Mounting Hardware: (not supplied)
 - 2 x 4-40 x 1" screw
 - 2 x # 4 washer
 - 2 x 4-40 self locking nut

Panel Cutout:
 0.825" H x 4.10" W
 *Matches old RM 2300

Build Your Own Part
 Number/User's Manual
 or Receive a Quote
 Online at:
<http://www.otekcorp.com/configurator/upm/>